



BEST BUILT BATCH FREEZERS SINCE 1905

12NW & 12LA
24NW & 24LA
44BLT & 44LA

INSTALLATION - OPERATION
CLEANING - MAINTENANCE



<<< WARNING >>>

- 1) STATE LAW REQUIRES THAT THE ELECTRICAL POWER TO THIS BATCH FREEZER BE INSTALLED ONLY BY A LICENSED ELECTRICIAN.

FAILURE TO HAVE A LICENSED ELECTRICIAN INSTALL THIS BATCH FREEZER WILL VOID YOUR WARRANTY.

- 2) IF THE BATCH FREEZER IS WATER COOLED, DO NOT TURN ON THE MAIN POWER UNTIL THE WATER LINES ARE CONNECTED AND TURNED ON. THE COMPRESSOR WILL START IMMEDIATELY WHEN ELECTRICITY IS CONNECTED. SERIOUS DAMAGE COULD OCCUR TO THE COMPRESSOR IF IT IS RUN WITHOUT THE WATER PROPERLY CONNECTED!

YOUR WARRANTY WILL BE NULL AND VOID IF THE BATCH FREEZER IS RUN WITHOUT WATER!

- 3) SECURE ALL PANELS TO THE BATCH FREEZER BEFORE TURNING ON THE ELECTRIC.
- 4) THE OCCASIONAL CYCLING OF THE COMPRESSOR ON AND OFF IS NORMAL AND IS DESIGNED TO EXTEND THE LIFE OF THE CONDENSING UNIT.

TABLE OF CONTENTS

Section 1	SAFETY	Page 3
Section 2	UNPACKING	Page 5
Section 3	INSTALLATION & COMMISSIONING	Page 7
Section 4	CLEANING & SANITIZING	Page 10
Section 5	OPERATION	Page 12
Section 6	OPERATING THE TOUCH SCREEN	Page 13
Section 7	CARE & MAINTENANCE	Page 23
Section 8	DESCRIPTION OF FUNCTION	Page 26
Section 9	ELECTRICAL DIAGRAM	Page 27
Section 10	TROUBLESHOOTING	Page 28
Section 11.0	RESETTING THE PRESSURE CONTROLLER	Page 29
Section 11.1	ADJUSTING THE DISCHARGE WATER TEMPERATURE	Page 31
Section 11.2	REPLACING THE DRIVE COUPLING	Page 33
Section 12	PARTS DIAGRAMS	Page 37
Section 13	RECIPES	Page 43
Section 14	WARRANTY	Page 47

Section 1 - SAFETY

First, be sure to read and understand this manual, and familiarize yourself and other operators with the batch freezer features, its operation, cleaning, and maintenance. Your batch freezer is equipped with several important safeguards that should never be removed or altered. DO NOT remove the following items:

- Door discharge guard - restricts fingers and utensils from coming in contact with moving blades/dasher and funnels product into smaller containers neatly.
- Inlet spout lid - restricts fingers from coming in contact with moving blades/dasher

On an air cooled batch freezer, the sides, front, and rear sections of the batch freezer have ventilation openings in them. All but the rear panel are louvered to deflect food and splashing liquids away from the inside. Never spray water directly at/into these openings.

If your batch freezer is set up with a plug on the end of its cord, make absolutely sure your hands are dry when plugging it in, or unplugging it.

The door and the dasher are heavy parts and are slippery when wet. Use extreme care handling them. Keep the floor and work area neat and dry to avoid slippage. Do not use the top of the batch freezer as a storage spot.

In addition to the above:

- DO NOT operate your batch freezer unless it is connected to a grounded power supply and was properly installed by a licensed electrician.
- DO NOT put fingers, hands, or any utensils in either the inlet spout or discharge spout.
- DO NOT operate the batch freezer unless it is properly assembled, and all guards are in place.
- DO NOT force any of the (washable) parts together or into/on the batch freezer. All parts should fit together easily.
- DO NOT operate the batch freezer with the freezing cylinder empty.
- DO NOT turn on the **batch freezer's** refrigeration switch with only water in the freezing cylinder.
- DO NOT let your product over-freeze during production.

Section 2 - UNPACKING

Upon delivery, fully inspect the pallet and packaging following the steps that were emailed to you prior to the shipment of your batch freezer.

12, 24, and 44 quart batch freezers are shipped with a corrugated shipping carton over the top of the batch freezer. The corrugated carton is nailed to two wooden runners inside the carton at the bottom. Using a razor knife, cut the carton down the two long sides just above the nails. When the carton is free, lift the carton up over the batch freezer and set it aside.

<<< *IMPORTANT* >>>

Make sure to keep the pallet, the corrugated carton or the wooden crate that covers the batch freezer during shipment and the hardware that secures the batch freezer to the pallet until you have successfully tested and ran the batch freezer for several weeks. If the batch freezer needs to be returned, it must be shipped back in the same manner it was received. If the batch freezer must be returned and these items have been discarded, you will be charged for these items and for the shipping of these items to you.

The batch freezer is bolted to the pallet it was shipped on from the underside. There are four **3/8"-16 hex bolts (9/16" head)** that go through the upper planks of the pallet and through holes in the **batch freezer's** frame. Remove all four bolts and unscrew all the wooden runners from the pallet. The batch freezer will now be free from the pallet. Save all components; they might be needed at a later date.

For 12 and 24 quart batch freezer, locate the box wrapped on top of the can stand (adjustable shelf) and remove the casters from the box. Notice that there are two different types of casters; one pair has a brake, and one pair does not have a brake. The pair with the brake should be installed at the front of the batch freezer, and the pair without the brake should be installed at the back of the batch freezer. (The 44-quart batch freezers do not come with casters as they are not recommended on a batch freezer of that size.)

Carefully slide the batch freezer to the edge of the pallet. With a helper steadying the batch freezer, slide one leg of the batch freezer just off the edge of the pallet. It may be necessary to tilt the batch freezer back slightly. Insert the screw portion of the caster through the hole in the bottom of the leg and install the washers and nut. Tighten the nut. Repeat this process for each of the remaining legs until all four casters are installed.

Now you can roll the batch freezer to its desired location.

Section 3 - INSTALLATION & COMMISSIONING

The protective plastic film on most outer surfaces of the batch freezer protects the finish during shipping. For air-cooled batch freezers, this film **MUST** be removed prior to operation of the batch freezer to allow proper airflow and heat dissipation. An air-cooled batch freezer **MUST** be able to pull in cool, clean room air from its rear intake. It requires a minimum of 18 inches of clear, unobstructed space on all four sides. Failure to allow adequate spacing and/or not removing the protective plastic film may result in poor performance, overheating, and shutdown.

ELECTRICAL CONNECTION: The 12, 24 and 44 quart batch freezer comes with a 72-inch-long flexible power cord that has no plug on it. This is because there are many ways to connect a large batch freezer like these to an electrical supply and electrical codes vary by location. Consult with your licensed electrician to decide what the proper connection is for your location.

You will find the electrical requirements for your batch freezer located on the serial number tag on the back of the batch freezer. Your electrician will need this information to install the proper electrical circuit for the batch freezer.

IMPORTANT NOTE: This batch freezer will not work if it is connected to a GFCI circuit. If the local electrical code requires that the batch freezer be connected to a GFCI circuit, contact Tech Support at Emery Thompson for further instructions. 718-588-7300.

WATER CONNECTION: If your batch freezer is water-cooled, as opposed to air-cooled, you will need to provide a water supply and a drain. The water supply should be a minimum of ½" pipe with a ¾" male garden hose fitting on the end. A shut-off valve is not necessary but is highly recommended.

All the batch freezers come with two 6-foot-long hoses with ¾" female garden hose fittings on both ends. The SUPPLY and DRAIN fittings are clearly marked on the back of the batch freezer. Using one of the hoses, connect the fitting marked SUPPLY to the water pipe. Using the remaining hose, or any other type of hose you want to use (**with a minimum of 3/8" ID**), connect the DRAIN hose to a floor drain, a wall drain, a sink, or whatever drain you want to use. Remember, the length of the drain line is not important, it can be as long or as short as you need it to be.

COMMISSIONING: After removing the plastic film from all of the panels of your batch freezer, connecting the supply and drain lines for your water-cooled batch freezer and turning on the water, you can now turn on the main power to the batch freezer.

Upon turning on the main power you will hear the refrigeration compressor start immediately. If your main power supply is single-phase, you can move on to RUNNING THE FREEZE TEST. If your main power supply is three-phase, you must confirm that the refrigeration compressor is operating correctly. If the refrigeration compressor is very loud and makes a rattling noise when it runs, it is probably running backward. This is common when starting up a new three-phase batch freezer. To correct this problem, have your electrician swap the black and white wires where the batch freezer is connected to the main power.

RUNNING THE FREEZE TEST: We recommend that the first thing you do is run a freeze test to make sure that your new batch freezer is operating properly. When we test batch freezers in our facility, we use sugar water because we run a lot of tests, and it would not be practical to use dairy mix. We know that if the batch freezer performs in a certain way with sugar water, it will perform in a similar manner with dairy mix. The only difference is that the amount of time it will take to make a batch of sugar water is longer than a batch of dairy mix.

To perform the freeze test, you can go to the touchscreen on your batch freezer: GET HELP, TROUBLESHOOTING, PERFORMING THE FREEZE TEST, or perform as follows:

12-Quart Batch Freezer:

- 7 quarts water
- 3-1/2 pounds sugar

Dissolve sugar into the water, pour into the batch freezer, turn on your dasher, turn on the refrigeration, and freeze for approximately 15-18 minutes.

24-Quart Batch Freezer:

- 14 quarts water
- 7 pounds sugar

Dissolve sugar into the water, pour into the batch freezer, turn on your dasher, turn on the refrigeration, and freeze for approximately 15-18 minutes.

44-Quart Batch Freezer:

- 28 quarts water
- 14 pounds sugar

Dissolve sugar into the water, pour into the batch freezer, turn on your dasher, turn on the refrigeration, and freeze for approximately 15-18 minutes.

Section 4 - CLEANING & SANITIZING

Note: Your local or state health inspector will always have jurisdiction over the methods and chemicals that are used for sanitation on your batch freezer. Our instructions are based on industry standards and should be discussed with your inspector.

The first step toward ensuring a clean and sanitary batch freezer is to understand the various parts that could or would come in contact with the food product.

All these parts are dishwasher safe, so the easiest way to clean them is to carefully arrange them in a dishwasher, positioning them so that open holes, pockets, and internal areas face down and stand the best chance of being hit with hot soapy water. Any of these parts can also be cleaned with liquid dish detergent and hot water, so long as they are thoroughly rinsed. The inside of the cylinder will have to be manually wiped out with warm soapy water and thoroughly rinsed.

Prior to each use your batch freezer must be sanitized. The purpose of sanitization is to kill any bacteria that may have grown on any food-contact part or surface.

To properly sanitize your batch freezer, it must first be reassembled after cleaning. Before putting the centershaft back into the batch freezer, note the centershaft has two o-rings on it. These two o-rings, and the circumference of the shaft just forward and rearward of the o-rings should have a generous coating of food-grade grease wiped on them. Once installed, any grease pushed off the centershaft can be wiped off with a paper towel.



12- & 24-Quart Center-Shaft



44-Quart Center-Shaft

When the batch freezer is fully assembled, with the door in place, and the four knobs hand tightened (do NOT use any tools to tighten the knobs), it is ready to be sanitized.

We recommend using a commercially available sanitizer/cleaner called **“Stera Sheen Green Label”**, although other brands exist as well. **Carefully follow the manufacturer’s instructions on mixing and use of their product.**

To learn how to sanitize the batch freezer, on your touchscreen, go to the **GET HELP, OPERATION, SANITIZING THE MACHINE** section.

Section 5 - OPERATION

Your new batch freezer is very easy to operate, with only two controls on it, the touchscreen, and the freeze button. The batch freezer was shipped fully assembled, and its' parts and features should be learned and understood.

On the upper left corner of the front of the batch freezer is the touchscreen.

On the upper right of the face of the batch freezer, there is a pushbutton switch. **This energizes the refrigeration condensing unit. Push in the button for "on" and push in the button for "off". In the "on" position, the button will illuminate blue. Ensure that the button is in the "off" position.**

When electrical power is first applied to the batch freezer, the compressor will immediately start, regardless of the position of the freeze button. The compressor will also start occasionally and run briefly, even if the batch freezer sits idle if there is power connected to it. This is a normal function and helps prolong the life of the compressor.

The normal sequence of operation, assuming the batch freezer is cleaned and sanitized, would be as follows:

flip the inlet spout guard open.

- pour in the mix/ingredients.
- close the inlet spout guard and lid.
- turn on the DASHER by selecting operating the touchscreen (pg. 11)
- push the REFRIGERATION button to turn it on.
- after 10-12 minutes, check the consistency of your product by slightly opening the gate to allow a small amount of product to come out then quickly close the **gate. This process is what you call a "cut-off check". If the product puddles into your container and has a runny consistency that trails down the discharge chute, then it isn't ready to extract. If the product has a clean cut at the gate and piles into your container, then you are ready to extract your product.**
- when the desired stiffness is achieved, **MAKE SURE** you immediately turn off the refrigeration, but leave your dasher running.
- open the discharge gate and allow the product to come out as fast as it will flow and fill your container(s).

Section 6 - OPERATING THE TOUCHSCREEN

The touchscreen is a powerful device filled with intuitive operating screens and helpful videos. This section will explain how to navigate the screens for safe and proper operation of the batch freezer.

The SCREEN SAVER

After applying power to the batch freezer, the SCREEN SAVER screen displays the rotating ET symbol. To begin operating the batch freezer or to watch a help video, touch the screen. The screen saver will appear after 1 minute of the screen not being touched unless the RUN screen is active.



The I WANT TO: Screen (Also called the HOME screen)

After touching the screen, the I WANT TO:/HOME screen is displayed. You can choose to MAKE ICE CREAM or GET HELP. Press the MAKE ICE CREAM button.



The CHOOSE RECIPE Screens

If you select the MAKE ICE CREAM from the I WANT TO:/HOME screen, the next screen you will see is the CHOOSE RECIPE screen. This screen allows the operator to choose the desired amount of overrun by the product name. (See the Overrun/Product/Speed chart on page 14, section 7.4.) This is the first screen of two CHOOSE RECIPE screens. Press the MORE RECIPIES button to go to the second screen or press the HOME button to go back to the I WANT TO:/HOME screen.



When you are on the second CHOOSE RECIPE screen, you can press the PREVIOUS RECIPIES button to return to the first CHOOSE RECIPE screen or you can press the HOME button to go back to the I WANT TO:/HOME screen. Press the button that corresponds to the product you want to make, on either screen, or choose the MANUAL option for a custom speed, and you will be taken to the START screen for that product.



The OVERRUN/PRODUCT/SPEED Chart

OVERRUN/PRODUCT/SPEED

Desired Overrun (%)	Product Name	Dasher Speed (RPM)
100	Homemade	234
65	Super Premium	165
65	Frozen Yogurt	160
50	Gelato	140
25	Cream Ice	200
25	Sherbet	200
35	Custard	135
20	Dairy Free	160
15 - 17	Italian Ice	234
15 - 17	Sorbet/Sorbetto	234
20	Frozen Lemonade	234

The START Screen

On the START screen you will find the name of the product you have selected at the top, and the speed that the dasher will turn in the middle of the two circles, when the START button is pressed. You will also find the MANUAL SPEED UP and DOWN buttons. These buttons can be used to adjust the dasher speed up and down as desired. The speed will change in 5 RPM increments each time the button is pressed. You will also see the status of the blades where it says BLADES STOPPED. The HOME button will take you back to the I WANT TO:/HOME screen and the BACK button will take you back to the CHOOSE RECIPE screen.



The RUN Screen

When the START button is pressed, the RUN screen is displayed, and the dasher and scraper blades begin to spin. You will see that the START button changes to a STOP button, the blades animation begins spinning, and the BLADES STOPPED message changes to BLADES SPINNING. The MANUAL SPEED-UP and DOWN buttons can be pressed to change the speed of the dasher if desired. Once the FREEZE switch is pressed, the BACK button in the upper right-hand corner of the screen changes to a timer and begins to count up. This timer can be used to monitor the time that a batch has been running. The timer stops and resets to 0:00 when the FREEZE switch is turned off.

FOR MODELS 12 AND 24 AIR-COOLED BATCH FREEZERS - In the bottom right corner is the PRESSURE display. This displays the pressure of the low side of the refrigeration system. This is useful information when troubleshooting refrigeration problems.

When the STOP button is pressed, the dasher stops and the screen changes back to the START screen.

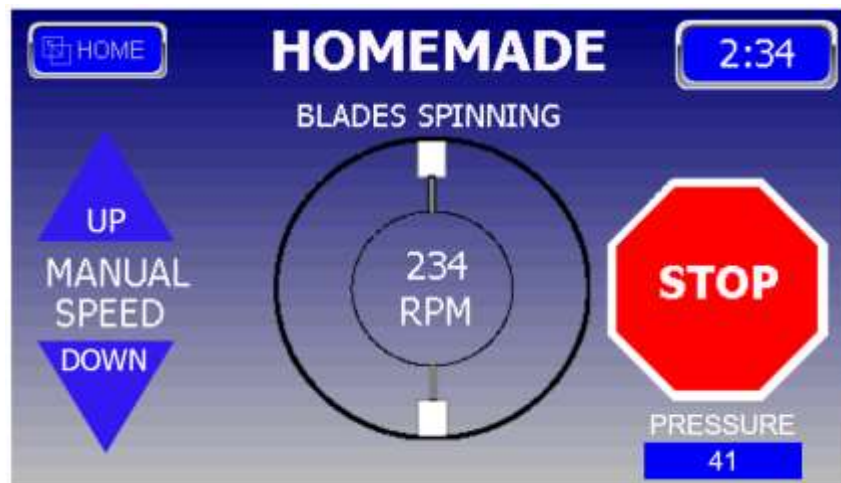

The GET HELP Screens

From the I WANT TO:/HOME screen, press the GET HELP button, which will take you to the SELECT YOUR MACHINE screen.



The SELECT YOUR MACHINE Screen

Touch the picture of the batch freezer that matches the batch freezer you want to get help with, and you will be taken to the HELP VIDEOS menu for your batch freezer. If you want to go back to the I WANT TO:/HOME screen, press the HOME button.



The HELP VIDEOS Screen

From the HELP VIDEOS menu, you can select the category of help you need. You can choose SETUP, OPERATION, MAINTENANCE and TROUBLESHOOTING topics. Also, you can press the HOME button to be taken back to the I WANT TO:/HOME screen or the BACK button to go back to the SELECT YOUR MACHINE screen.



The rest is self-explanatory and very easy to navigate. Simply choose a topic, press the button for the video of your choice, and watch the video.

The ALARM Screens

If the dasher motor speed controller experiences a problem, an alarm screen will be displayed. There are two different alarm screens that may be displayed: COMMON ALARMS and OTHER ALARMS. Some alarms can be cleared by pressing the RESET button, while others may cause the dasher to stop turning, and soon thereafter, the refrigeration system to shut down. Pressing the REMEDY button will provide information for resolving the problem that caused the alarm. If the batch freezer stops due to one of these alarms, it is important to take note of the alarm and call Tech Support at Emery Thompson if the alarm persists. If the alarm cannot be cleared by pressing the RESET button, turn off the power to the batch freezer for 60 seconds and turn it back on.

OTHER ALARMS	
mm/dd HH:mm ACT Description	
mm/dd HH:mm ACK Description	
mm/dd HH:mm RTN Description	
mm/dd HH:mm RTN Description	

HISTORY	
mm/dd HH:mm ACT Description	
mm/dd HH:mm ACK Description	
mm/dd HH:mm RTN Description	
mm/dd HH:mm RTN Description	

REMEDY **RESET**

COMMON ALARMS	
mm/dd HH:mm ACT Description	
mm/dd HH:mm ACK Description	
mm/dd HH:mm RTN Description	
mm/dd HH:mm RTN Description	

HISTORY	
mm/dd HH:mm ACT Description	
mm/dd HH:mm ACK Description	
mm/dd HH:mm RTN Description	
mm/dd HH:mm RTN Description	

REMEDY **RESET**

The WARNING Screen

As the product mixes in the cylinder, the product gets constantly thicker. As the product gets thicker, the power required to drive the dasher motor increases. As the power to drive the dasher motor increases, the IOC monitors its output power to ensure that it does not rise to a level that will damage the dasher motor. If the output power reaches the preset high level, the WARNING screen will be displayed, and an audible alarm will begin to sound. If this happens you should press the ACKNOWLEDGE button, turn off the FREEZE button and begin to extract the product. Pressing the ACKNOWLEDGE button will cause the screen to display the RUN screen and cause the audible alarm to stop. If the product is not extracted the WARNING screen will come back on 30 seconds after the ACKNOWLEDGE button was pressed. This will continue to happen until the dasher shuts itself off.



The SYSTEM Screen

The touchscreen requires an operating system just like a computer. There is no reason for the user to access the SYSTEM screens, but you should be aware that they exist as it is possible to call up the screens accidentally. The SYSTEM screens will appear if you touch the screen in the upper right-hand corner. If the system screen is accidentally displayed, touch the screen anywhere outside the SYSTEM screen area to close the screen, or wait 1 minute and it will go off on its own.



Section 7 - CARE & MAINTENANCE

One of the best features of an Emery Thompson batch freezer is the small amount of maintenance and the ease of care required to keep it running and looking new. The materials we use for our parts are the best available for their intended purpose and are designed for maximum longevity.

The outer casing of your batch freezer is all heavy-gauge stainless steel and will only require a daily wipe down with a mild detergent and warm water. Using a stainless-steel cleaner/polish will also help keep it looking new.

Performing regular maintenance on your Emery Thompson batch freezer will keep it running at its peak performance for many years. The maintenance required is based on how frequently you run the batch freezer and how long you run the batch freezer. It is easiest to think of this as how many hours per week (HPW) you run your batch freezer.

	0 to 15 HPW*	15 to 30 HPW*	30 to 45 HPW*	More Than 45 HPW*
Lubricate the Dasher/Center Shaft O-rings (1 & 2)	Every time you run the batch freezer or after 8 hours of continuous operation	Every time you run the batch freezer or after 8 hours of continuous operation	Every time you run the batch freezer or after 8 hours of continuous operation	Every time you run the batch freezer or after 8 hours of continuous operation
Lubricate the Discharge Gate O-ring (1 & 2)	Daily	Daily	Daily	Daily
Lubricate the Door O-ring	Never	Never	Never	Never
Replace the Dasher/Center Shaft O-rings (1 & 2)	Once each year	Every 9 months	Every 6 months	Every 3 months
Replace the Discharge Gate O-ring (1 & 2)	Only if it leaks	Only if it leaks	Only if it leaks	Only if it leaks
Replace the Door O-ring (1)	Only if it leaks	Only if it leaks	Only if it leaks	Only if it leaks
Replace the Door Gasket (2)	Only if it leaks	Only if it leaks	Only if it leaks	Only if it leaks
Replace the Blade Springs (1 & 2)	Every 2 years	Every 18 months	Once each year	Every 6 months
Replace the Door Gate Spring(s) (1 & 2)	Only if it leaks	Only if it leaks	Only if it leaks	Only if it leaks
Sharpen the Scraper Blades (1 & 2)	Every 5 to 7 years	Every 4 to 6 Years	Every 3 to 5 years	Every 2 to 4 years
Replace the Scraper Blades (1 & 2)	After sharpening 1 to 3 times	After sharpening 1 to 3 times	After sharpening 1 to 3 times	After sharpening 1 to 3 times
Inspect/Clean the Drip Tray (2)	Once each Year	Every 9 months	Every 6 months	Every 3 months
Drain the Water (3)	Every year prior to possible freeze	Every year prior to possible freeze	Every year prior to possible freeze	Every year prior to possible freeze
Clean the Cooling Coils (4)	Once each year	Every 9 months	Every 6 months	Every 3 months

(1) CB-200 and CB-350 batch freezer only

(2) 12, 24- and 44-quart batch freezer only

(3) Water cooled batch freezer only

(4) Air cooled batch freezer only

*HPW =
HOURS PER
WEEK

If your batch freezer has been stored in an unheated area and is brought into a warmer area for use, allow it to sit for at least 24 hours in the warmer temperature; condensation can build up on cold surfaces, including inside the speed controller, touchscreen, contactor, and overload relay, which could lead to malfunctions.

Never transport, store, or use your batch freezer in any position other than upright on its feet. Oil in the refrigeration compressor could travel into areas of the batch freezers piping where it will remain trapped.

Your batch freezer has been tested and is rated to run in ambient air temperatures as high as 104° F, and as low as 50° F. Operation in temperatures at the high end of the temperature range may slightly increase the freezing time of your product, and at the low end of the temperature range may slightly decrease the freezing time of the product.

Section 8 - Description of Function

The purpose of this section is to explain how your batch freezer is supposed to work so that anyone working on the batch freezer will have a thorough understanding, which should make troubleshooting easier. Please refer to the electrical drawing on the next page for the reference numbers in parentheses.

With the main power present at the batch freezer, the touchscreen (1) should be active, and the freeze button (2) should be in the off position.

When a product is selected on the touchscreen and the start button is pressed, the dasher motor speed controller (3) sends power to the dasher motor (4) and the dasher motor runs at the speed pre-programmed for that product. Also, the auxiliary contacts COM and NO on the dasher motor speed controller (3) close completing that portion of the circuit that is in series with the freeze button (2).

With the dasher motor running and the freeze button turned on, the solenoid valve (5) on the high-pressure side of the refrigeration system is energized and CR-1 (11) is energized. When the contacts in CR-1 close, the freeze button lights up and input Q1 on the touchscreen becomes true, which starts the timer on the touchscreen.

When the solenoid valve opens, and the pressure builds above 40 psi on the low-pressure side, the pressure controller energizes the coil in the contactor in the pressure controller. When the contactor closes, the refrigeration compressor comes on.

As the condensing unit runs, the refrigeration coils wrapped around the product cylinder begin to get cold.

Ideally the low-pressure side should drop to 28 to 32 psi and the high-pressure side should run at 275 to 325 psi. During the last several minutes of a batch you may see the low-pressure side drop again by about 2 psi.

When the product is ready, the refrigeration button is turned off and the solenoid valve closes and the contacts in CR-1 open. The compressor continues to run until the low-pressure side of the refrigeration system drops below 10 psi and the pressure controller turns off the power to the contactor coil and the contactor turns off the power to the refrigeration compressor.

When the STOP button on the touchscreen is pressed, the dasher motor speed controller stops sending power to the dasher motor and the motor stops.

Section 9 - ELECTRICAL DIAGRAM

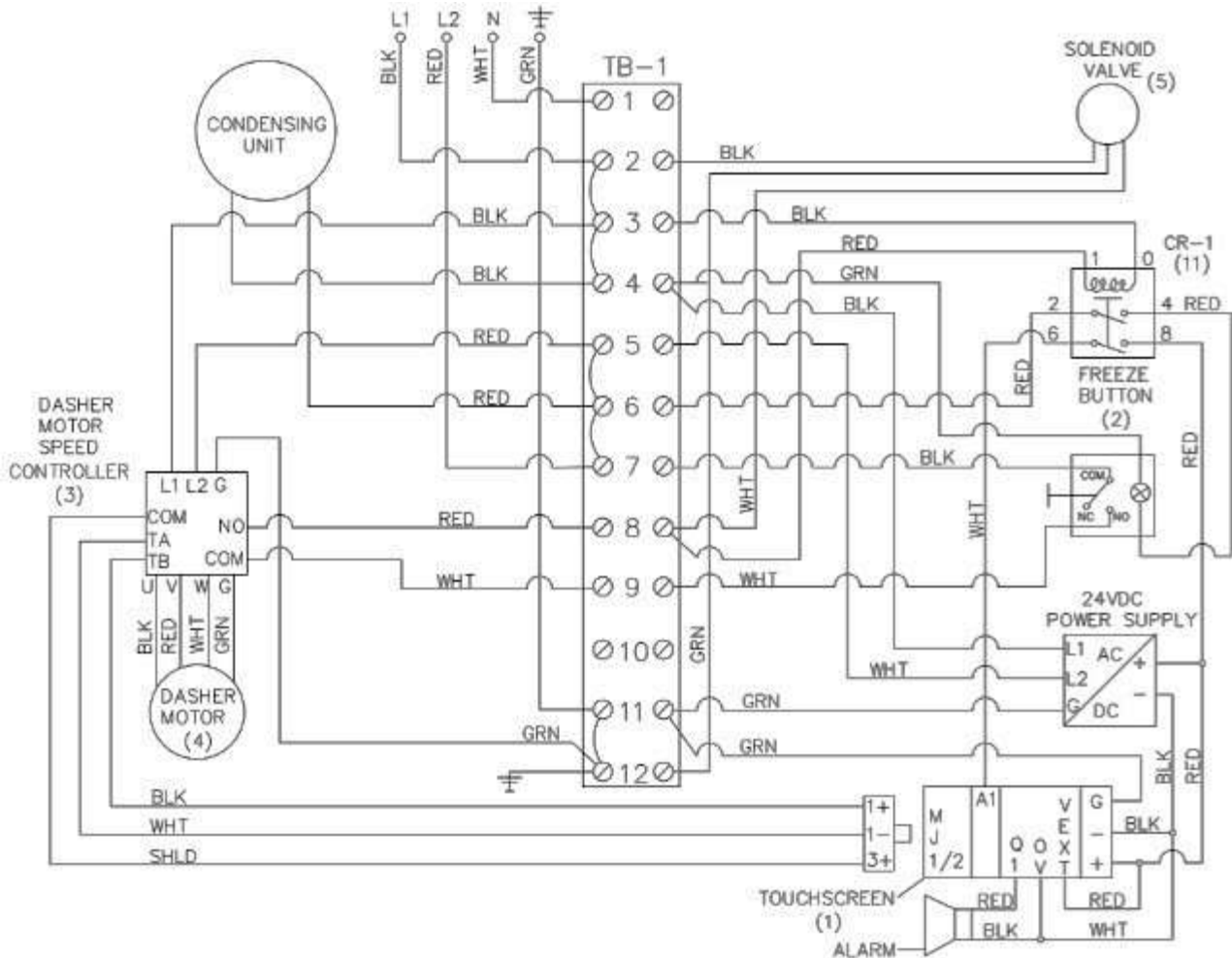

**12-, 24- & 44-QUART BATCH FREEZER
208-230V/1PH/60HZ**

If your batch freezer is 3-Phase, see the following page.

Section 10 - TROUBLESHOOTING

Problem	Possible Solutions
Dasher not spinning	Contents frozen too stiff - allow to thaw and soften or remove bulk of product . Push “stop” button, and attempt restart.
Dasher spins, but refrigeration will not run. (Refrigeration switch illuminated)	Compressor has tripped off. Turn off switch; allow unit to cool for 1 hour minimum; attempt restart.
Unit runs, but takes too long, or longer than usual to freeze product.	Airflow restricted or coils dirty/blocked. Provide adequate airflow and/or clean coil area.
Squeaking noise when dasher runs.	Ensure that dasher shaft has been lubricated properly at o-ring area.
Grinding noise while making product; build-up on cylinder walls.	Blades installed incorrectly; one or more blade springs missing.
Sliding gate is leaking	Gate springs are old and need to be replaced.
Door will not pull back on studs; blades sticking out beyond face.	Rear of dasher is not engaged into drive motor socket. Rotate dasher and push backward.
Batch freezer sways/shakes while running	Feet or mounting surface uneven; adjust feet so that each has equal pressure.
Door is leaking around edge(s)	Door gasket uneven/not fully seated in its groove. Remove and reinstall or replace.
Screen shows that blades are spinning but they are not. -Or- Screen shows that the blades are not spinning but they are.	Disconnect main power to the batch freezer for 1 full minute and turn back on.

Section 11.0 - RESETTING THE PRESSURE CONTROLLER

The pressure controller is the device that causes the condensing unit to operate correctly. The pressure controller is programmed to CUT IN at 40 psig and CUT OUT at 10 psig. It also shuts off the refrigeration compressor to prevent it from becoming damaged when the pressure on the low-pressure side of the refrigeration system gets too low or too high, or when the pressure on the high-pressure side of the refrigeration system gets too high.

Common issues that cause the pressure controller to go into FAULT:

All Units

- Long period of time between uses.
- Cleaning the cylinder with hot water.

Water Cooled Units

- Cooling water is not turned on.
- Cooling water line kinked or crushed (SUPPLY line and/or DRAIN line).

Air Cooled Units

- Heat exchanger blocked or covered.
- Heat exchanger too close to the wall.
- Not enough clearance around unit.
- Room temperature exceeding 100° F.

To reset the pressure controller:

1. Remove the stainless-steel panel that covers the pressure controller.
 - a. For 12- and 24-quart batch freezers, remove the front bottom panel.
 - b. For 44-quart batch freezers, remove the right-side panel closest to the front.
2. **Press and hold the "START" button for 3 seconds. (See photo on next page.)**

3. Release the "START" button briefly.
4. Press and hold the "START" button again for 3 seconds.
5. The digital display should read "RST".
6. If the digital display shows "POF" instead of "RST", press and hold both the up arrow and the down arrow for more than 3 seconds and the display should read "PON".
7. Repeat steps 2, 3 and 4. The display should read "RST".
8. If it does read "RST" replace the stainless-steel panel. If it doesn't read "RST", call Emery Thompson Tech Support at (718) 588-7300.



PRESSURE CONTROLLER

Section 11.1 - ADJUSTING THE DISCHARGE WATER TEMPERATURE

Water-cooled batch freezers require a supply line (where the water enters the batch freezer) and a discharge line (where the water exits the batch freezer). The discharge water temperature is critical and should be checked several times a year to ensure it is set correctly. It is best to check it in the middle of the summer and the middle of the winter as those times will typically be the most extreme.

To adjust the water valve, perform the following steps:

1 - Remove the side cover to access the water valve. The water valve is behind the right-side cover on the model 12 and 24, and behind the left rear side panel on the model 44.



12- & 24-Quart Water Valve



44-Quart Water Valve

2 - Make sure that the water supply line is turned on.

3 - With mix in the batch freezer, turn on the dasher and turn on the refrigeration switch.

4 - After about 5 minutes, insert a thermometer in the stream of discharge water. The discharge water temperature should be 108°F (+/- 2°F) for the 12- and 24-quart batch freezers, and 113°F (+/- 2°F) for the 44 quart batch freezers.

5 - If the discharge water temperature is set properly, there is nothing else to do. If the discharge water temperature is outside the acceptable range, it should be adjusted. Turn the stem on top of the water valve counterclockwise to increase the discharge water temperature or turn the stem on top of the water valve clockwise to decrease the discharge water temperature.

6 - Continue to adjust the water valve until the correct water temperature is achieved and maintained.

7 - If it is not possible to adjust the water valve so the discharge water temperature is set properly, it may be necessary to replace the water valve.

Section 11.2 - REPLACING THE DRIVE COUPLING

The drive coupling, which connects the center shaft (at rear of cylinder) to the speed reducer (2018 and older) or the gear motor (2018 or newer), is designed to last the life of your batch freezer. However, as a safety feature this coupling will break if excessive torque is applied to the center shaft. This will occur if the batch freezer is operated incorrectly and the product in the cylinder is allowed to over-freeze, or an obstruction stops the dasher instantly, e.g. If a batch of product is started freezing and the batch freezer is left unattended and allowed to run indefinitely, the product will eventually freeze solid causing the dasher to stop spinning and break the coupling. Never run your batch freezer unattended!

REMOVAL:

- 1) Disconnect power to the batch freezer.
- 2) Remove the dasher and the center shaft.
- 3) Remove the side panels and the top lid.
- 4) Remove the plastic Delrin chain and the square-bored drive sprocket. A damaged coupling will have one or more of the following issues: a) a broken or cracked plastic chain, b) a broken or cracked square-bored drive sprocket, or c) a broken or cracked speed reducer output shaft coupling sprocket.
- 5) Loosen and remove the two set screws in the speed reducer output shaft coupling sprocket. Spray penetrating lubricant into both set screw holes, and around the shaft on both sides of the sprocket.
- 6) To remove the speed reducer output shaft coupling sprocket, tap around the backside of the sprocket in several places with a small **hammer until it is driven off the shaft. If the sprocket won't come off by tapping with a hammer, insert a wooden block and a tapered chisel between the face of the speed reducer and the face of the sprocket hub. Tap firmly on the end of the chisel with a hammer and the sprocket should slide off the shaft.**



REPLACING:

1) Carefully inspect the speed reducer output shaft and its keyway. Both must be free of rust, scale, and burrs. The old key can be used over in the new installation, but again - check its condition - it may need cleaning and/or filing. Regardless if you use the old key or a new one, it must fit into the keyway on the speed reducer shaft. Insert it into the keyway, flush to the end of the shaft.

2) The speed reducer output shaft coupling sprocket is the one with the round bore. The toothed side of the sprocket will face the freezing cylinder of the batch freezer (NOT THE SPEED REDUCER). Be sure that both **set screws are backed far enough out of the sprocket that they don't** contact with the shaft while sliding the sprocket into position.

3) Lubricate the bore of the sprocket and the speed reducer shaft, and start the new sprocket onto the shaft, lining up the keyway in the sprocket to the key. It may be necessary to tap the sprocket onto the speed reducer. If it cannot simply be tapped on, take it back off, and carefully sand/file the shaft until the sprocket can be tapped on. Set the sprocket

deep enough onto the shaft so that the end of the shaft is flush with the face of the sprocket. Do not tighten the set screws yet!

4) Remove any link pin from the new plastic chain by pressing the pin out of the link with a pin punch, or something similar, like a nail. Hold the square-bored sprocket in place and wrap the chain around both sprockets. Make sure the chain meshes with the teeth on both sprockets and wraps all the way around until the two-end links align, and the link pin can be inserted through the two links.

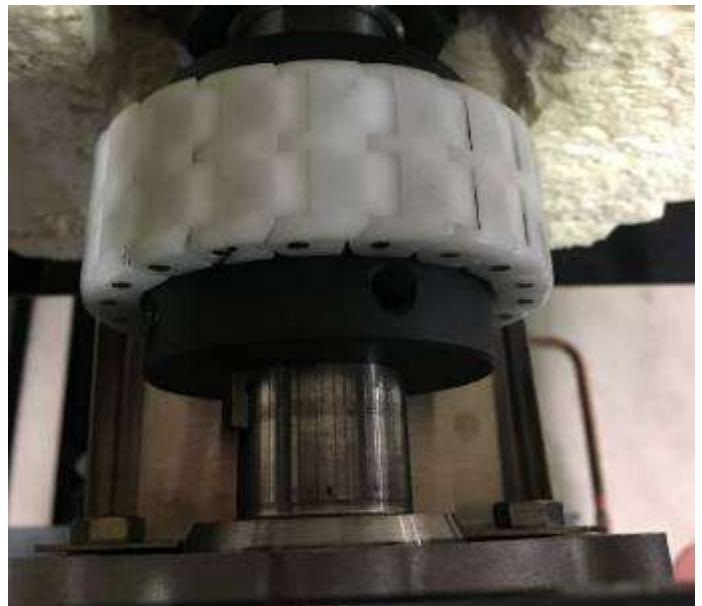

5) Before tightening the set screws in the speed reducer output shaft coupling sprocket, be sure to check and set the gap between the face of the center shaft and face of the square-bored drive sprocket. Refer to the photo below, making sure that the center shaft is pushed back as far as it will go. **There should be between 1/16" and 1/8" of a gap between the shoulder of the center shaft and the face of the coupling sprocket.** Once this gap is correct, tighten both set screws.

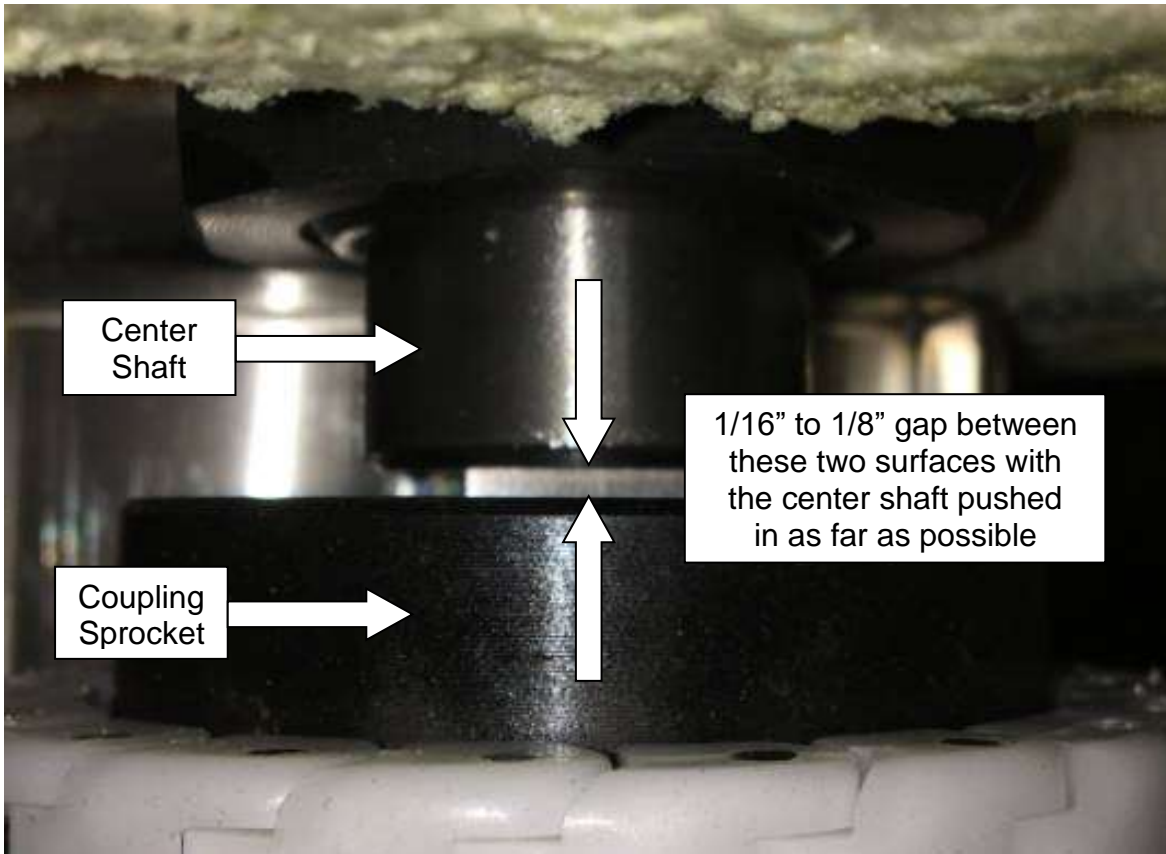

6) With the installation now complete, clean and grease the o-ring area of the center shaft prior to final assembly.

Section 12 - PARTS DIAGRAMS

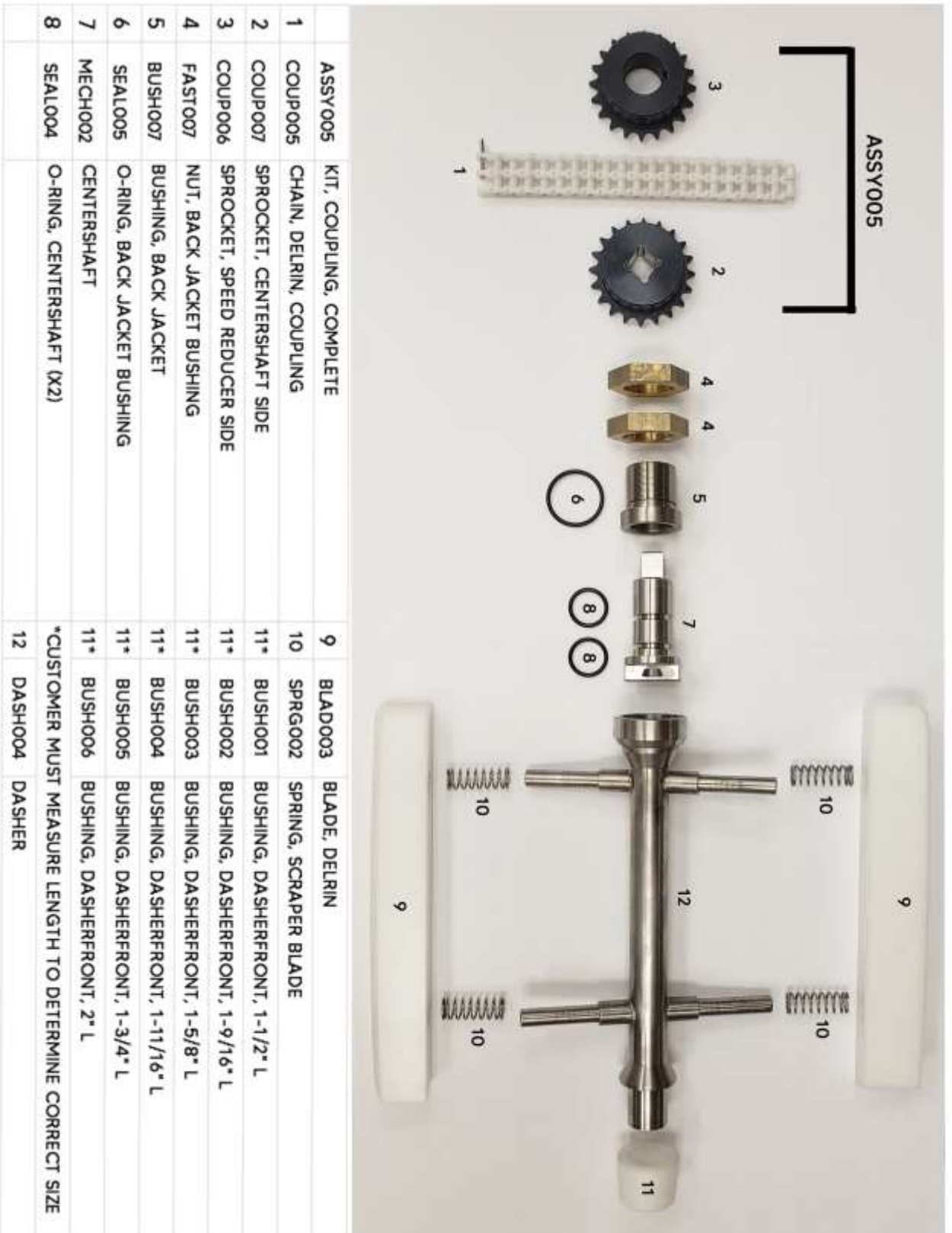

	ASSY005	KT, COUPLING, COMPLETE	9	BLADD003	BLADE, DELRIN
1	COUP005	CHAIN, DELRIN, COUPLING	10	SPRG002	SPRING, SCRAPER BLADE
2	COUP007	SPROCKET, CENTERSHAFT SIDE	11*	BUSH001	BUSHING, DASHERFRONT, 1-1/2" L
3	COUP006	SPROCKET, SPEED REDUCER SIDE	11*	BUSH002	BUSHING, DASHERFRONT, 1-9/16" L
4	FAST007	NUT, BACK JACKET BUSHING	11*	BUSH003	BUSHING, DASHERFRONT, 1-5/8" L
5	BUSH007	BUSHING, BACK JACKET	11*	BUSH004	BUSHING, DASHERFRONT, 1-11/16" L
6	SEAL005	O-RING, BACK JACKET BUSHING	11*	BUSH005	BUSHING, DASHERFRONT, 1-3/4" L
7	MECH002	CENTERSHAFT	11*	BUSH006	BUSHING, DASHERFRONT, 2" L
8	SEAL004	O-RING, CENTERSHAFT (X2)			
			12	DASH004	DASHER

*CUSTOMER MUST MEASURE LENGTH TO DETERMINE CORRECT SIZE



ASSY005	KIT, COUPLING, COMPLETE	9	BLAD003	BLADE, DELRIN	
1	COUP005	CHAIN, DELRIN, COUPLING	10	SPRG002	SPRING, SCRAPER BLADE
2	COUP007	SPROCKET, CENTERSHAFT SIDE	11*	BUSH001	BUSHING, DASHERRONT, 1-1/2" L
3	COUP006	SPROCKET, SPEED REDUCER SIDE	11*	BUSH002	BUSHING, DASHERRONT, 1-9/16" L
4	FAST007	NUT, BACK JACKET BUSHING	11*	BUSH003	BUSHING, DASHERRONT, 1-5/8" L
5	BUSH007	BUSHING, BACK JACKET	11*	BUSH004	BUSHING, DASHERRONT, 1-11/16" L
6	SEAL005	O-RING, BACK JACKET BUSHING	11*	BUSH005	BUSHING, DASHERRONT, 1-3/4" L
7	MECH002	CENTERSHAFT	11*	BUSH006	BUSHING, DASHERRONT, 2" L
8	SEAL004	O-RING, CENTERSHAFT (X2)	*CUSTOMER MUST MEASURE LENGTH TO DETERMINE CORRECT SIZE		
		12	DASH005	DASHER	

12/24QT DOOR
ASSY 2.0

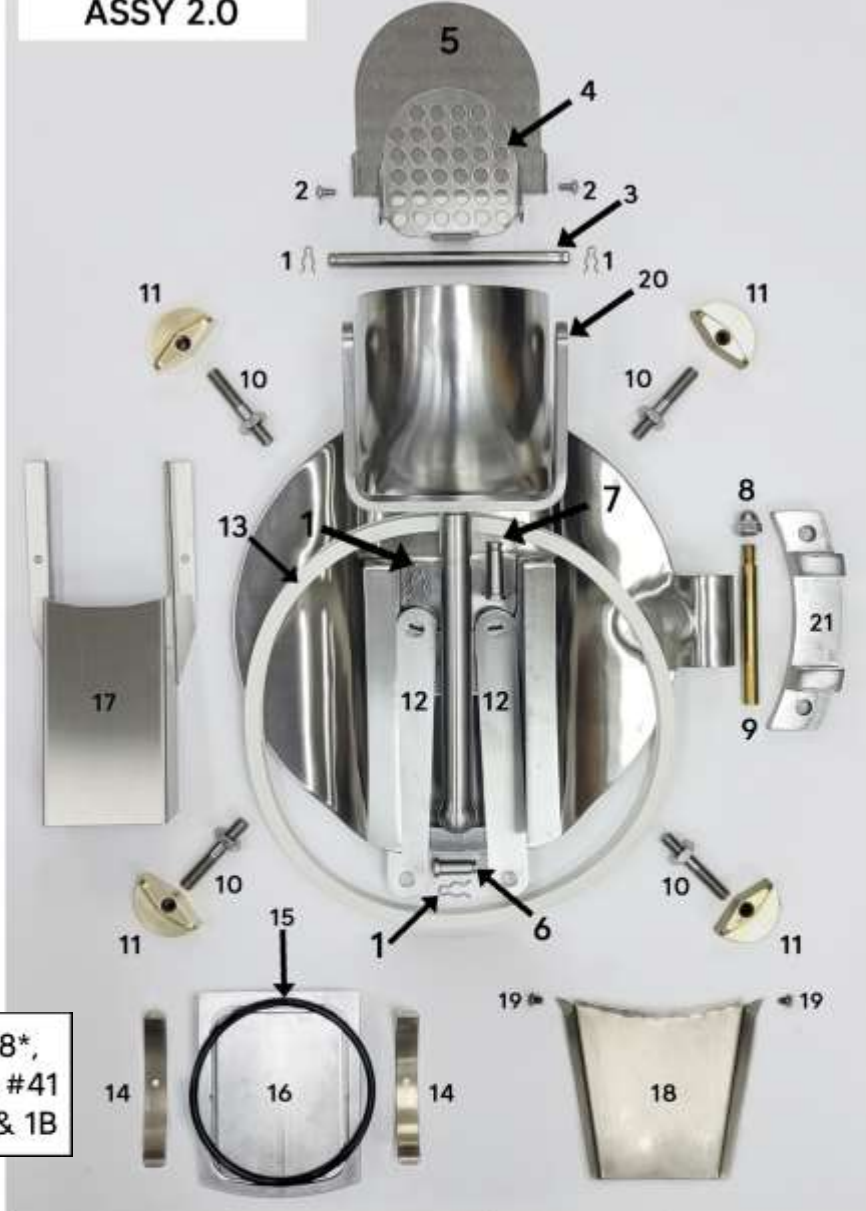

#16*, 17* & 18*,
refer to page #41
diagrams 1A & 1B

1	FAST003	CLIP, BLADEHOLDER, SMALL "A"	11	MECH032	KNOB, DOOR, FRONT COVER
2	FAST020	SCREW, DUST COVER	12	MECH036	LINKAGE BAR, GATE-TO-HANDLE
3	FAST037	ROD, GATE HANDLE	13	SEAL014	GASKET, FRONT COVER, DOOR
4	STML013	GUARD, DOOR THROAT	14	SPRG007	SPRING, GATE PRESSURE
5	STML025	DUST COVER, LID	15	SEAL027	O-RING, GATE
6	FAST041	PIN, SHORT, GATE HANDLE	16*	MECH016	GATE
7	FAST042	PIN, LONG, GATE HANDLE	17*	STML148	GUARD, DOOR DISCHARGE (VERSION 2)
8	FAST040	NUT, ACORN	18*	STML149	CHUTE, DISCHARGE
9	FAST038	PIN, DOOR HINGE	19	FAST025	SCREW, DISCHARGE CHUTE
10	FAST043	SUD & NUT, DOOR KNOB	20	MECH030	HANDLE, GATE
			21	MECH034	HINGE, DOOR (NOT SOLD)

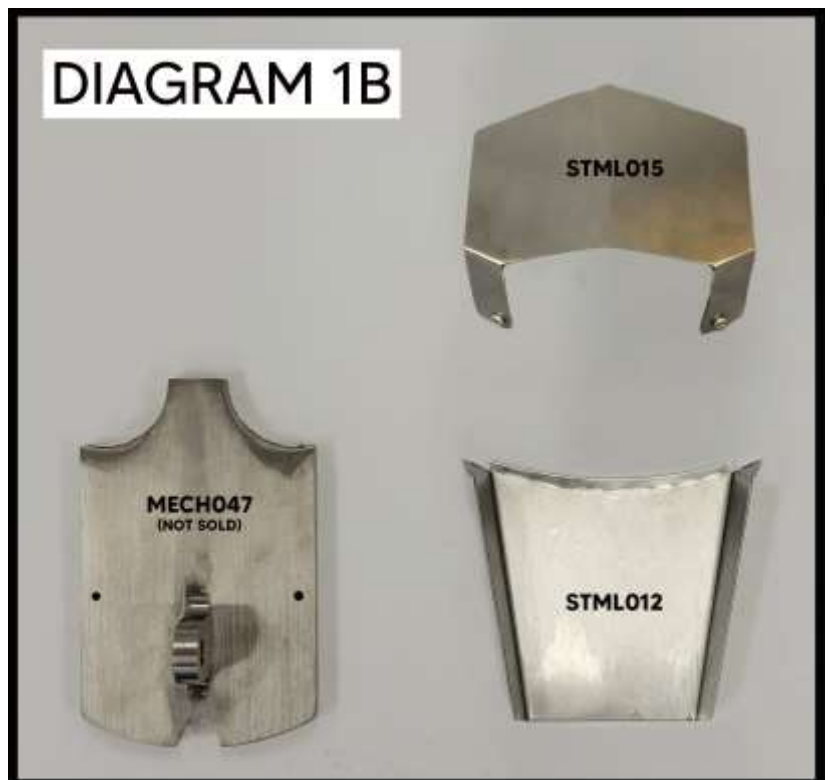

DIAGRAM 1A:

IF CONVERTING FROM DIAGRAM 1B, ALL PARTS FROM DIAGRAM 1A WILL FIT ALL YEARS OF THE 12 & 24 QT MODELS.

DIAGRAM 1B:

GATE (MECH047) IS NO LONGER AVAILABLE. YOU MUST CONVERT TO #16 ON DIAGRAM 1A.



44QT MIX ASSY 2.0



	ASSY008	KIT, CHAIN COUPLING	8*	BUSH001	BUSHING, DASHERFRONT, 1-1/2" L
1	BUSH008	BUSHING, BACK JACKET	8*	BUSH002	BUSHING, DASHERFRONT, 1-9/16" L
2	SEAL003	O-RING, BACK JACKET BUSHING	8*	BUSH003	BUSHING, DASHERFRONT, 1-5/8" L
3	FAST008	NUT, BACK JACKET BUSHING, RETAINING	8*	BUSH004	BUSHING, DASHERFRONT, 1-11/16" L
4	MECH003	CENTERSHAFT	8*	BUSH005	BUSHING, DASHERFRONT, 1-3/4" L
5	SEAL001	O-RING, CENTERSHAFT (X2)	8*	BUSH006	BUSHING, DASHERFRONT, 2" L
6	BLAD004	BLADE, DELRIN (X2)	*CUSTOMER MUST MEASURE LENGTH TO DETERMINE CORRECT BUSHING		
7	SPRG003	SPRING, SCRAPER BLADE (X6)	9	DASH006	DASHER

**44QT DOOR
ASSY 2.0**

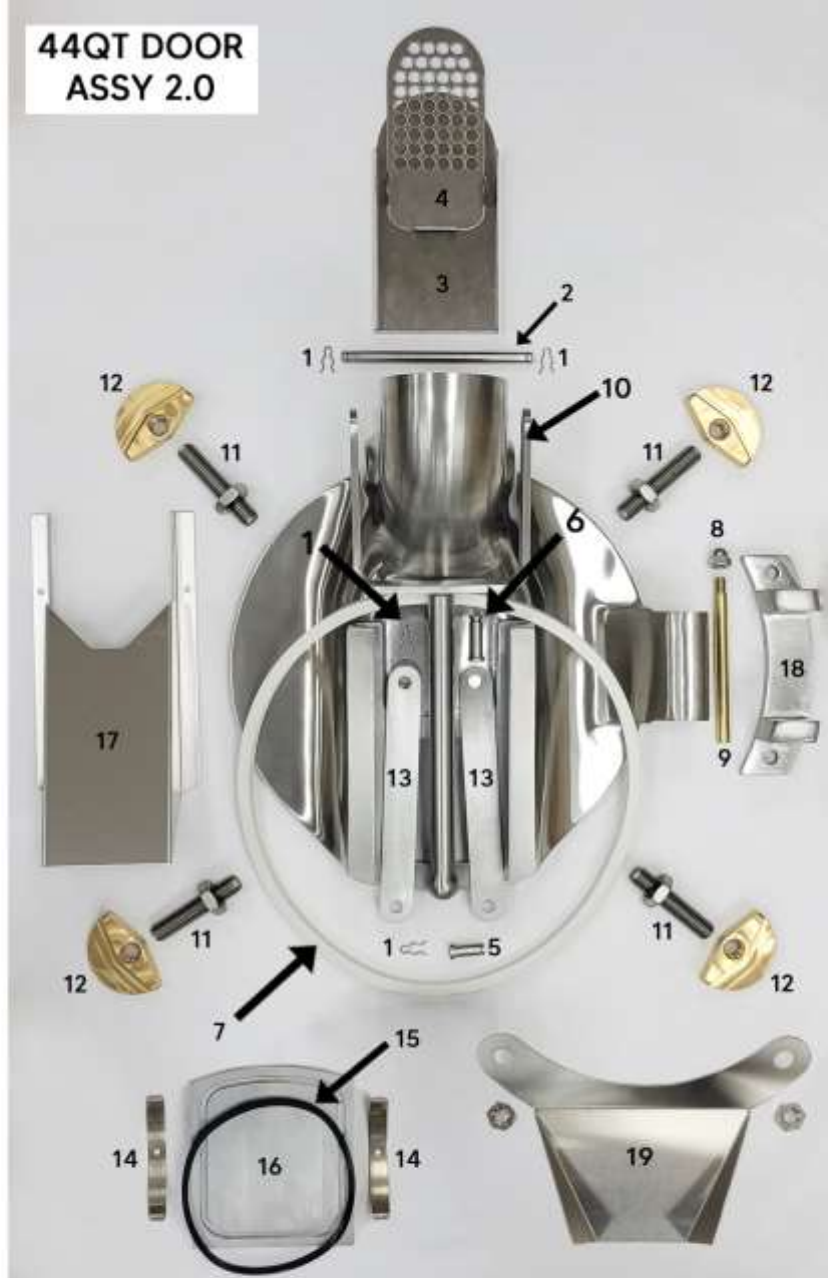

1	FAST003	CLIP, BLADE HOLDER, SMALL "A"	10	MECH031	HANDLE, GATE
2	FAST037	ROD, GATE HANDLE	11	FAST044	STUD & NUT, DOOR KNOB
3	STML043	DUST COVER, LID	12	MECH033	KNOB, DOOR, BRASS
4	STML014	GUARD, DOOR THROAT	13	MECH037	LINKAGE BAR, GATE-TO-HANDLE (X2)
5	FAST041	PIN, GATE HANDLE, SHORT	14	SPRG007	SPRING, GATE PRESSURE
6	FAST042	PIN, GATE HANDLE, LONG	15	SEAL028	O-RING, GATE
7	SEAL015	GASKET, FRONT COVER, DOOR	16	MECH004	GATE
8	FAST040	NUT, ACORN	17	STML100	GUARD, DOOR DISCHARGE (VERSION 2)
9	FAST039	PIN, HINGE, DOOR	18	MECH035	HINGE, DOOR (NOT SOLD)
			19	STML081	DISCHARGE CHUTE W/HEX NUTS, OPTIONAL

Section 13 - RECIPES

The following recipes are very basic, and require few ingredients, but are a good starting point to familiarize yourself with freezing times and consistencies, as well as begin to form a production routine. NEVER put undissolved sugar into your batch freezer for any recipe. Dissolve it first, then pour it into the batch freezer.

Lemon Italian Ice

12QT Batch Freezer:

- 6 quarts water
- 4 pounds sugar
- Zest grated from 2 large lemons
- 40 ounces of fresh-squeezed lemon juice

24QT Batch Freezer:

- 12 quarts water
- 8 pounds sugar
- Zest from 4 large lemons
- 80 ounces fresh-squeezed lemon juice

44QT Batch Freezer

- 22 quarts water
- 15 pounds sugar
- Zet from 8 large lemons
- 146 ounces fresh-squeezed lemon juice

Mix the sugar with the water until the sugar is dissolved. Slowly pour this into your batch freezer. Add the lemon juice and lemon zest; start the dasher.

Then turn on the refrigeration and freeze for 10-12 minutes for the 12 & 24 quart batch freezers and approximately 11-13 minutes for the 44 quart batch freezers and continue to check for the desired consistency **performing the "cut-off check."**

Coffee Ice Cream

12QT Batch Freezer:

- 6 quarts dairy mix
- 2 ounces vanilla extract
- 10 ounces instant coffee (measured by volume)

24QT Batch Freezer:

- 12 quarts dairy mix
- 4 ounces vanilla extract
- 20 ounces instant coffee (measured by volume)

44QT Batch Freezer

- 22 quarts dairy mix
- 8 ounces vanilla extract
- 37 ounces instant coffee (measured by volume)

Mix all ingredients together, then pour into the batch freezer and start the dasher.

Then turn on the refrigeration and freeze for 12-14 minutes for the 12 & 24 quart batch freezers and approximately 15-18 minutes for the 44 quart batch freezers and continue to check for the desired consistency **performing the “cut-off check.”**

Verry Berry Wine Sorbet

12QT Batch Freezer:

- 3 quarts water
- 3 quarts red sweet wine
- 4 pounds sugar
- 32 ounces frozen mixed berries, thawed

24QT Batch Freezer:

- 6 quarts water
- 6 quarts red sweet wine
- 8 pounds sugar
- 64 ounces frozen mixed berries, thawed

44QT Batch Freezer

- 11 quarts water
- 11 quarts red sweet wine
- 15 pounds sugar
- 117 ounces frozen mixed berries, thawed

Mix the sugar with the water until the sugar is dissolved. Slowly pour the mixture into your batch freezer. Add the rest of the ingredients and start the dasher.

Then turn on the refrigeration and freeze for 12-14 minutes for the 12 & 24 quart batch freezers and approximately 15-18 minutes for the 44 quart batch freezers, and continue to check for the desired consistency **performing the “cut-off check.”**

For more recipes, you can visit our website at:
www.emerythompson.com

OR

Visit us on our YouTube channel:
[EmeryThompsonMachine](https://www.youtube.com/channel/UC...)

You can also purchase our
Recipe book which contains
Over 100 recipes

On how to make:

- HOMEMADE ICE CREAM
- DAIRY FREE ICE CREAM
- GELATO
- ITALIAN ICE
- SORBET
- CREAM ICE (SHERBET)

With short stories and
vintage ads of the history of
Emery Thompson since 1905

8-1/2 X 11" HARDCOVER BOK, 172 PAGES

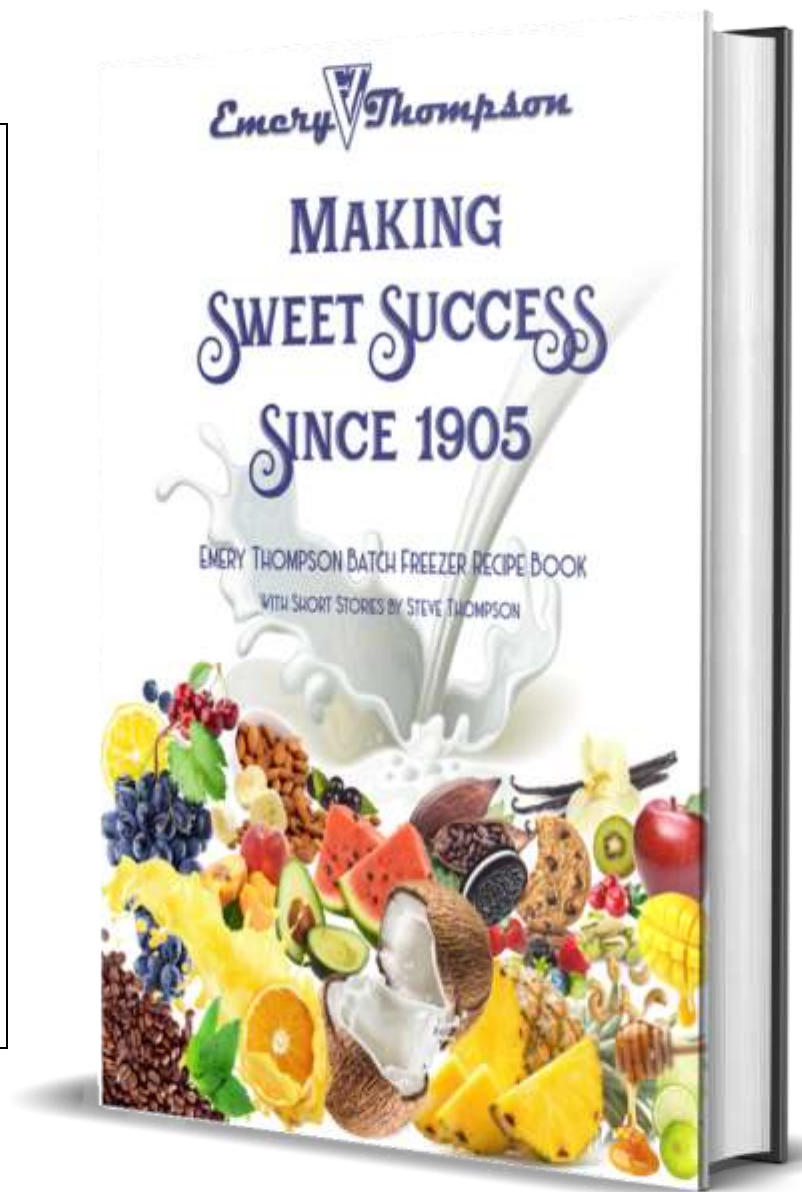

Section 14 - WARRANTY

Emery Thompson Machine & Supply CO. 12 Month Limited Warranty on New Freezers

Notice:

The batch freezer warranty starts when you receive your batch freezer. Except as limited and conditioned hereafter, The Emery Thompson **Machine & Supply CO (hereinafter referred to as the "Company")** warrants to the original purchaser and user only, the said batch freezer and all parts thereof to be free from defects in material and workmanship for a period of twelve (12) months from the *date of shipment from the Company's* factory if it is proved to our satisfaction to be inoperative due to defects in material or factory workmanship. Caution: This warranty is valid only if the required service is provided by an authorized agent of Emery Thompson Machine & Supply CO or person or persons directly authorized by Emery Thompson Machine & Supply CO to perform the necessary repairs. Emery Thompson Machine & Supply CO can be reached at 718-588-7300-factory, or fax at 352-345-8007.

Definitions. **The term "original purchaser" as used herein, shall be deemed** to mean that person, firm, or association, or corporation for whom the equipment referred to herein is originally sold to.

The term "Company and or Factory" shall mean the plant of the company located at 15350 Flight Path Drive, Brooksville, FL 34604 U.S.A.

Labor and Transportation Charges. Emery Thompson Machine & Supply CO assumes no liability under the warranty for any transportation charges or labor expenses incident to its work under this warranty, such transportation expenses and labor costs to be assumed and paid by the Purchaser.

Use and Care of Machine. Purchaser shall only use the batch freezer in **accordance with the operator's manual provided by the Company and no** liability under this Warranty or otherwise shall attach by reason of a defect caused by negligence, abnormal use, misuse or abuse of said batch

freezer, or for any accident that may occur to said batch freezer or any part thereof after said batch freezer has left the factory of the Company, nor for any defect that may arise by placing any part in said batch freezer which has not been manufactured or approved by the Company. Misuse of the batch freezer includes owner's failure to: (1) clean, lubricate and assemble per the Operator's Manual; (2) replace damaged or worn "wear items", including but not limited to o-rings, gaskets, front bearing, rear bearing, scraper blades, centershaft, water valve. (3) handle parts properly, resulting in breakage; or (4) use unauthorized service agencies.

Purchaser shall not remove, alter, or deface the serial number on said batch freezer and there shall be no liability of Emery Thompson Machine & Supply CO if any of same shall occur.

Repair or Replacement of Defective Parts. **The Company's obligation** under this warranty is limited to the repair of defective parts at the **Brooksville, Florida plant or replacement from the Company's own inventory.** In the event the Company ships a replacement part prior to the return of the defective part, payment will be required for said part and credit issued or reimbursement made only if the defective part is returned within thirty (30) days from the replacement date.

WARNING: The use of alternate refrigerants will void your warranty. Use **only the refrigerant specified on this unit's data plate (located on rear panel of the batch freezer).**

Emery Thompson Machine & Supply CO reserves the right to make design changes, or to make additions to, or improvements on its products without imposing any obligation on itself to make such changes on its products previously manufactured.

THIS WARRANTY IS EXCLUSIVE AND IS IN LIEU OF ALL OTHER WARRANTIES AND REMEDIES UNDER THE LAW, INCLUDING ANY IMPLIED WARRANTY OF MERCHANTABILITY OR FITNESS FOR A PARTICULAR PURPOSE. **THE ORIGINAL OWNER'S SOLE REMEDY WITH RESPECT TO ANY EMERY THOMPSON BATCH FREEZER SHALL BE REPAIR OR REPLACEMENT OF DEFECTIVE COMPONENTS UNDER THE TERMS OF THIS WARRANTY.**

WHAT IS NOT COVERED BY THIS WARRANTY Emery Thompson Machine & Supply CO's sole obligation under this warranty is limited to either repair or replacement of parts, subject to the additional limitations below. This warranty neither assumes nor authorizes any person to assume obligations other than those expressly covered by this warranty. NO CONSEQUENTIAL DAMAGES. EMERY THOMPSON MACHINE & SUPPLY CO IS NOT RESPONSIBLE FOR ECONOMIC LOSS; PROFIT LOSS; OR SPECIAL, INDIRECT, OR CONSEQUENTIAL DAMAGES, INCLUDING WITHOUT LIMITATION, LOSSES, OR DAMAGES ARISING FROM FOOD OR PRODUCT SPOILAGE REGARDLESS OF WHETHER OR NOT THEY RESULT FROM REFRIGERATION FAILURE. WARRANTY IS NOT TRANSFERABLE; this warranty is not assignable and applies only in favor of the original purchaser/user to whom delivered. ANY SUCH ASSIGNMENT OR TRANSFER SHALL VOID THE WARRANTIES HEREIN AND SHALL VOID ALL WARRANTIES, EXPRESS OR IMPLIED, INCLUDING ANY WARRANTY OF MERCHANTABILITY OR LABOR COVERAGE FOR COMPONENT FAILURE OR OTHER THE WARRANTY AS PROVIDED IN OUR INSTRUCTION MANUAL WITH THE UNIT AND AT www.emerythompson.com. EMERY THOMPSON MACHINE & SUPPLY CO will not be held responsible for the following external factors: ALTERATION, NEGLIGENCE, ABUSE, MISUSE, ACCIDENT, DAMAGE DURING TRANSIT OR INSTALLATION, FIRE, FLOOD, ACTS OF GOD, OR IMPROPER ELECTRICAL CONNECTIONS. EMERY THOMPSON MACHINE & SUPPLY CO IS NOT RESPONSIBLE FOR THE REPAIR OR REPLACEMENT OF FAILED OR DAMAGED COMPONENTS RESULTING FROM ELECTRICAL POWER FAILURE, THE USE OF EXTENSION CORDS, LOW VOLTAGE, OR VOLTAGE DROPS TO THE UNIT. THERE ARE NO IMPLIED WARRANTY OF MERCHANTABILITY OR FITNESS FOR A PARTICULAR PURPOSE.

NO DISTRIBUTOR, DEALER OR OTHER PERSON IS AUTHORIZED TO MAKE ANY COMMITMENT OR ASSUME ANY LIABILITY ON BEHALF OF EMERY THOMPSON MACHINE & SUPPLY CO BEYOND THIS WARRANTY. THERE ARE NO WARRANTIES, WHICH EXTEND BEYOND THE DESCRIPTION ON THE FACE HEREOF.