

EMERY THOMPSON BATCH FREEZER INSTALLATION

OPERATING, MAINTENANCE
AND CLEANING MANUAL

TWELVE QUART
TWENTY-FOUR QUART
FORTY-FOUR QUART





**STATE LAW REQUIRES THAT THE ELECTRIC POWER TO
THIS MACHINE BE INSTALLED BY A LICENSED
ELECTRICIAN – ONLY**

FAILURE TO ADHERE TO THIS WILL VOID YOUR WARRANTY

CAUTION

**** IF YOUR MACHINE IS WATER COOLED ****
DO NOT TURN ON YOUR BATCH FREEZER
UNTIL THE WATER LINES ARE HOOKED UP!!

- 1. SERIOUS DAMAGE COULD OCCUR TO YOUR COMPRESSOR IF IT IS RUN WITHOUT THE WATER PROPERLY HOOKED UP!**
- 2. YOUR WARRANTY WILL BE NULL AND VOID IF THE MACHINE IS RUN WITHOUT WATER!**

WARNING

YOUR COMPRESSOR WILL IMMEDIATELY START WHEN THE ELECTRIC IS HOOKED UP.

- 1. SECURE ALL PANELS TO THE MACHINE BEFORE TURNING ON THE ELECTRIC.**
- 2. THE OCCASIONAL CYCLING OF THE COMPRESSOR ON AND OFF IS NORMAL AND IS DESIGNED TO EXTEND THE LIFE OF YOUR CONDENSING UNIT.**



YOUR FROZEN DESSERTS

(FREEZING UP YOUR MACHINE)

What you did wrong!

AND

MAKING HALF BATCHES

When our customers first run their new Emery Thompson 12, 24, or 44 quart batch freezer what we too often hear is how they froze the machine up solid and got an error code on the Infinite Overrun Touch Screen.

Here is a list of what went wrong:

1. **They did not read the instruction manual.** Unlike a cell phone (that does not come with an instruction manual), your \$\$\$\$\$ investment has this quite comprehensive manual. Your batch freezer is not “Intuitive.” You must read and understand the entire instruction manual – and especially read the warnings! It’s a lot of money to spend and not operate it properly.
2. If the scraper blades (the two long pieces of Delrin plastic) are **not installed properly**, the machine will start making noise in a few minutes and either freeze up or take three times as long to make a batch. The curved tip of the blade goes to the back of the machine and the other tip of the blade which is cut off on a 90 degree angle and has a small round dimple goes to the front of the machine. If this is wrong the machine will not operate properly. You need to be aware of this Each and Every time you assemble the machine.
3. You cannot do “**test**” half batches one after another. With so little product in the freezing chamber your chances of “freezing up” are greatly increased. The freezing time of a half batch will be greatly shorter, so you **MUST** watch your batch very carefully. If you hear any grinding or banging sounds coming from your freezing cylinder, the product is freezing to the walls of the cylinder. **STOP** the machine, rinse it out, take it apart and start over. If you must do half batches (because you’re making a flavor no one likes but you) you should rinse the machine out after each batch to warm the cylinder back up. This is not necessary if you are running full batches.



Half Batch quantities:

12 quart batch freezer:

Dairy products – 4 quarts into the machine

Water ice products – 6 quarts into the machine

24 quart batch freezer:

Dairy products – 8 quarts into the machine

Water ice products – 12 quarts into the machine

44 quart batch freezer:

Dairy products – 16 quarts into the machine

Water ice products – 24 quarts into the machine

4. **YOUR BLEND:** You're going to have to trust me on this one – I've been building and running Emery Thompson Batch Freezers since I was sixteen years old. Your "blend" which came from a magazine, cookbook or you "created it" will work fine in your home ice cream freezer or a cheap Italian or Chinese freezer. Why? Because it takes them a very long time to freeze – 40 minutes or more as compared to $\frac{1}{4}$ of that time in your new Emery Thompson. And it has little or no freezing capabilities beyond your home refrigerator. Your Emery Thompson has tremendous freezing capability. But without the **proper level of solids**, your recipe is going to freeze up in a modern piece of dairy equipment. Solids come in the form of sugars, cream and some nuts like cashews. Splenda, Stevia and Xylitol have no solids. Milk does not have enough solids. Coconut water has virtually no solids. Cream of Coconut does. While you can use all these products in your formula, they alone will not freeze. You are welcome to call us and we can discuss your formula with you... but physics and the laws of freezing cannot be changed. Water and flavor do not alone make a sorbet and milk alone does not make an ice cream.



Table of Contents

1.	IMPORTANT WARNING INFORMATION
2.	DON'T DO THIS! (AND WHY)
4.	Table of Contents
6.	Quick Start Guide
8.	Warranty Information
11.	Safety Information
13.	Installing Your Batch Freezer
16.	Dasher and Scraper Blades
18.	Infinite Overrun Control (I.O.C.)
20.	Cleaning and Sanitizing Your Batch Freezer
22.	Typical Department of Agriculture Regulations
23.	Making Your First Batch
24.	Making Ice Cream, Gelato, Sherbet, and Water Ices
26.	Steve Thompson's "Secret" Italian Ice Formula
27.	Care and Maintenance
30.	Removing/Replacing the Complete Coupling
33.	Gasses and Settings
34.	Technical Support
35.	Replacement Part Numbers and Diagrams - All Models
35.	12QT Mix Assembly 1.0
36.	12QT Mix Assembly 1.1



Table of Contents (cont.)

37.	12QT Mix Assembly 2.0
38.	12QT Mix Assembly 2.1
39.	24QT Mix Assembly 1.0
40.	24QT Mix Assembly 2.0
41.	24QT Mix Assembly 2.1
42.	12/24QT Door Assembly 1.0
43.	44QT Mix Assembly 1.0
44.	44QT Mix Assembly 2.0
45.	44QT Door Assembly 1.0
46.	Troubleshooting
46.	Reset Mechanical Pressure Control Switch
50.	Reset Digital Pressure Control Switch



QUICK START GUIDE

WELCOME TO EMERY THOMPSON! Thank you for your purchase of a new Emery Thompson Batch freezer. The following is a quick start guide to get your new machine up and running as soon as possible. If at any time you have a question about the operation of your new machine, please don't hesitate to call me at our factory @ 718-588-7300. Best regards,

Steve Thompson

- **Open the front cover and remove the dasher assembly. Set aside in a safe place.**
- **You will need a licensed electrician to make your electrical connections.**
 - **The electrician will wire your machine from the rubber service cord provided. Please see the serial tag on rear panel of the machine for exact electrical specifications and refer to the INSTALLING YOUR BATCH FREEZER section of this manual (Installation - Electrical) to be sure the machine is connected properly.**
- **If your machine is water cooled, inlet and outlet water connections must be made at this time. Both inlet/outlet connection hoses are included in your machine for a flexible connection to your water supply & drain. See the INSTALLING YOUR BATCH FREEZER section of this manual (Installation - Plumbing). Note: air-cooled machines do not require water connections.**
- **Your new machine was shipped “factory fresh” and thus has some residual polishing agents on the freezing parts. You should scrub the beater, front cover, barrel and center shaft with a scouring brush (Brillo or SOS) prior to your first use. Dishwashing soap (Joy, Dawn, etc.) makes the job easier. Do not use any harsh agents or scouring brushes on the outer skin of the machine.**
- **NOTE: The protective plastic film on most outer surfaces of the machine protects the finish during shipping. This film **MUST** be removed prior to operation of the machine to allow proper airflow and heat dissipation.**



- **Freezer test your machine. A simple mixture of sugar and water will help you determine that your machine is ready to use.**
 - **For a 12 Quart machine, dissolve 3 1/2 pounds of sugar with 7 Quarts of cold water.**
 - **For a 24 Quart machine, dissolve 7 pounds of sugar with 14 Quarts of cold water.**
 - **For a 44 Quart machine, dissolve 14 pounds of sugar with 28 Quarts of cold water.**
 - **Freeze in the cylinder for approximately 18 minutes.**



Emery Thompson Machine and Supply Company, Inc. 12 Month Limited Warranty On New Freezers

Notice: The machine warranty starts when you receive your machine.

Except as limited and conditioned hereafter, The Emery Thompson Machine and Supply Company, Inc. (hereinafter referred to as the “Company”) warrants to the original purchaser and user only, the said machine and all parts thereof to be free from defects in material and workmanship for a period of twelve (12) months from the *date of shipment* from the Company’s factory if it is proved to our satisfaction to be inoperative due to defects in material or factory workmanship. Caution: This warranty is valid only if required service is provided by an authorized agent of Emery Thompson Machine and Supply Company or person or persons directly authorized by Emery Thompson to perform the necessary repairs. Emery Thompson can be reached at 718-588-7300-factory, 352-796-0720-fax or STEVE@EMERYTHOMPSON.COM electronic mail.

Definitions. The term “original purchaser” as used herein, shall be deemed to mean that person, firm, or association, or corporation for whom the equipment referred to herein is originally sold to.

The term “Company and or Factory” shall mean the plant of the company located at 15350 Flight Path Drive, Brooksville, FL 34604 U.S.A.

Labor and Transportation Charges. Emery Thompson Machine and Supply Company assumes no liability under the warranty for any transportation charges or labor expenses incident to its work under this warranty, such transportation expenses and labor costs to be assumed and paid by the Purchaser.

Use and Care of Machine. Purchaser shall only use the machine in accordance with the operator’s manual provided by the Company and no liability under this Warranty or otherwise shall attach by reason of a defect caused by negligence, abnormal use, misuse or abuse of said machine, or for any accident that may occur to said machine or any part thereof after said machine has left the factory of the Company, nor for any defect that may arise by placing any part in said machine which has not been manufactured or approved by the Company. Misuse of the machine includes owner’s failure to: (1) clean, lubricate and assemble per the Operator’s Manual; (2) replace damaged or worn “wear items”, including but not limited to o-rings, gaskets, front bearing, rear bearing, scraper blades, drive shaft, water valve. (3) handle parts properly, resulting in breakage; or (4) use unauthorized service agencies.

Purchaser shall not remove, alter or deface the serial number on said machine and there shall be no liability of Emery Thompson Machine and Supply Company if any of same shall occur.



Repair or Replacement of Defective Parts. The Company's obligation under this warranty is limited to the repair of defective parts at the Brooksville, Florida plant or replacement from the Company's own inventory. In the event the Company ships a replacement part prior to the return of the defective part, payment will be required for said part and credit issued or reimbursement made **only if the defective part is returned within thirty (30) days from replacement date.**

WARNING: The use of alternate refrigerants will void your warranty. Use only the refrigerant specified on this unit's data plate (located on rear panel of machine).

Emery Thompson Machine and Supply Company, Inc. reserves the right to make design changes, or to make additions to, or improvements on its products without imposing any obligation on itself to make such changes on its products previously manufactured.

THIS WARRANTY IS EXCLUSIVE AND IS IN LIEU OF ALL OTHER WARRANTIES AND REMEDIES UNDER THE LAW, INCLUDING ANY IMPLIED WARRANTY OF MERCHANTABILITY OR FITNESS FOR A PARTICULAR PURPOSE. THE ORIGINAL OWNER'S SOLE REMEDY WITH RESPECT TO ANY EMERY THOMPSON FREEZER SHALL BE REPAIR OR REPLACEMENT OF DEFECTIVE COMPONENTS UNDER THE TERMS OF THIS WARRANTY.

WHAT IS NOT COVERED BY THIS WARRANTY Emery Thompson Machine's sole obligation under this warranty is limited to either repair or replacement of parts, subject to the additional limitations below. This warranty neither assumes nor authorizes any person to assume obligations other than those expressly covered by this warranty. NO CONSEQUENTIAL DAMAGES. EMERY THOMPSON IS NOT RESPONSIBLE FOR ECONOMIC LOSS; PROFIT LOSS; OR SPECIAL, INDIRECT, OR CONSEQUENTIAL DAMAGES, INCLUDING WITHOUT LIMITATION, LOSSES, OR DAMAGES ARISING FROM FOOD OR PRODUCT SPOILAGE REGARDLESS OF WHETHER OR NOT THEY RESULT FROM REFRIGERATION FAILURE. WARRANTY IS NOT TRANSFERABLE, This warranty is not assignable and applies only in favor of the original purchaser/user to whom delivered. ANY SUCH ASSIGNMENT OR TRANSFER SHALL VOID THE WARRANTIES HEREIN AND SHALL VOID ALL WARRANTIES, EXPRESS OR IMPLIED, INCLUDING ANY WARRANTY OF MERCHANTABILITY OR LABOR COVERAGE FOR COMPONENT FAILURE OR OTHER THE WARRANTY AS PROVIDED IN OUR INSTRUCTION MANUAL WITH THE UNIT AND AT www.emerythompson.com. EMERY THOMPSON will not be held responsible for the following external factors: ALTERATION, NEGLIGENCE,



ABUSE, MISUSE, ACCIDENT, DAMAGE DURING TRANSIT OR INSTALLATION, FIRE, FLOOD, ACTS OF GOD, OR IMPROPER ELECTRICAL CONNECTIONS. EMERY THOMPSON IS NOT RESPONSIBLE FOR THE REPAIR OR REPLACEMENT OF FAILED OR DAMAGED COMPONENTS RESULTING FROM ELECTRICAL POWER FAILURE, THE USE OF EXTENSION CORDS, LOW VOLTAGE, OR VOLTAGE DROPS TO THE UNIT. THERE ARE NO IMPLIED WARRANTY OF MERCHANTABILITY OR FITNESS FOR A PARTICULAR PURPOSE.

NO DISTRIBUTOR, DEALER OR OTHER PERSON IS AUTHORIZED TO MAKE ANY COMMITMENT OR ASSUME ANY LIABILITY ON BEHALF OF EMERY THOMPSON MACHINE AND SUPPLY COMPANY, INC. BEYOND THIS WARRANTY. THERE ARE NO WARRANTIES, WHICH EXTEND BEYOND THE DESCRIPTION ON THE FACE HEREOF.

WARNING: If the refrigeration system for this freezer is water cooled, care must be taken to keep the machine maintained and stored at temperatures above 32 degrees F. at all times. If the temperature could possibly drop below 32 degrees, then all water must be forcibly removed from the system using compressed gas. Failure to do this could result in the interior components of your machine freezing up and causing costly damage to your machine Failure to maintain your machine at a temperature above 32 degrees *will* void your warranty.



FOR YOUR SAFETY!

We have designed guards for your Emery Thompson Batch Freezer. These guards are incorporated into your batch freezer for the safety of you and your employees – Please see that the guards are used at all times and do not make any modifications to your machine to defeat their purpose. Safety is our main concern and should be your concern too.

The **inlet guard** is designed to allow you to feed large ingredients into your batch freezer prior to its start-up. Health laws require that you close the inlet cover prior to start-up of the batch freezer. Closing the inlet cover will automatically put the inlet guard in place. ***Do not operate your batch freezer with the inlet guard and inlet cover open.***

The **discharge guard** is installed under the front cover and the discharge chute. ***Do not operate your batch freezer with the outlet guard removed.***

IMPORTANT SAFEGUARDS

- DO NOT** Operate your freezer before you and all other operators read this manual.
- DO NOT** Operate this unit unless it is properly grounded and all electrical and plumbing connections have been made by qualified personnel.
- DO NOT** Operate the unit with larger fuses or breakers than are specified on the freezer nameplate.
- DO NOT** Allow untrained personnel to operate this unit. Failure to fully train personnel in the proper use of this or any other “specialized equipment” may result in severe personal injury to fingers or hands from hazardous moving parts.
- DO NOT** Put hands or fingers into the inlet or discharge openings.
- DO NOT** Remove front cover or dasher assembly unless all control switches are in the **Off** position.
- DO NOT** Try to help the ice cream or water ices to come out of the discharge by putting any foreign object in the discharge opening.
- DO NOT** Force any parts on your batch freezer – everything fits together easily.
- NEVER** Run the batch freezer with the freezing barrel empty or dry and the dasher in place.

Failure to follow these instructions may result in personal injury to the operator and may void your warranty.



INSTALLING YOUR BATCH FREEZER

Choosing a location

1. Locate your batch freezer away from any source of artificial heat.
2. The area should be clean, dry and well ventilated.
3. Properly grounded electrical power must be available. See the nameplate on the rear panel of the unit for electrical requirements.
4. The selected floor space should be both solid and level. The barrel is pitched forward so that on a level floor, all rinse water will easily drain out.
5. If your unit is water cooled, the water outlet should be directed to an indirect waste such as a floor drain or a sink. This will allow you to feel the temperature of the wastewater while the machine is running. A properly operating machine will have discharge water at a temperature of approximately 108 degrees F.
6. **NOTE: The protective plastic film on most outer surfaces of the machine protects the finish during shipping. This film MUST be removed prior to operation of the machine to allow proper airflow and heat dissipation.**

CAUTION: All power must be turned off or disconnected before removing any of the machines panels. Do not run your new machine until the electrical connections are made and if water-cooled, the water lines are connected and turned on.



Installation – Electrical

Please refer to the electrical specifications found on the serial tag located on the rear panel of the machine.

1. YOUR NEW MACHINE COMES WITH A LINE CORD THAT CAN BE USED TO CONNECT YOUR MACHINE TO YOUR ELECTRICAL SUPPLY.
2. The drive shaft should spin COUNTER-CLOCKWISE on all machines. If your machine is a single-phase model, the center shaft is already spinning in the proper direction (COUNTER CLOCKWISE). **If your machine is three (3) phase**, the sound of the compressor must be noted as soon as power is applied to the machine. A loud and rattling compressor indicates the machine is connected out-of-phase, leg one and leg three of power must be interchanged. If your machine is single-speed, you can also note the rotation of the dasher/blade assembly, verifying that it spins counter-clockwise.
3. Again, if your machine is single (1) phase it will automatically spin in the proper direction and no further tests are required.

TWELVE QUART

1 Phase	40 amps. Breaker	# 8 wire
3 phase	30 amps. Breaker	# 10 wire

TWENTY-FOUR QUART

1 Phase	40 amps. Breaker	# 8 wire
3 Phase	30 amps. Breaker	# 10 wire

FORTY-FOUR QUART

3 Phase	50 amps. Breaker	# 8 wire
---------	------------------	----------

Installation – Plumbing

1. All water-cooled machines (12, 24 and 44Qt.) should have their inlet hose connected to a wall spigot/shutoff valve supplied by a MINIMUM 1/2" pipe-size supply line. The machine's outlet hose simply discharges clean hot water and can be routed to a floor drain, into a sink or connected directly to a sanitary sewer pipe.
2. The water inlet is connected to the brass colored water valve. This valve has been pre-set at our factory and **should not** need any adjustment. (***) See Important Exception below.)



3. The return connection is located next to the inlet connection. **Note:** The machine will discharge the water away from the machine so it is not necessary to have a floor drain nearby. In fact, if necessary, the drain can be run up the side of the wall and across the ceiling to another room and still drain properly. Most health departments want or require an “indirect waste.” Consult with your health department.

IMPORTANT EXCEPTION***

If your water supply is from a deep well or if you live in a cold climate or a *very* warm climate, your water supply may affect the proper operation of your new machine. This can be easily adjusted by a qualified refrigeration specialists who will adjust your DISCHARGE WATER to a temperature of approximately 108 degrees F.

When your water cooled batch freezer is set to operate within these parameters, you will achieve the fastest freezing times and the most efficient operation.

DASHER AND SCRAPER BLADES

Our new dasher and blade assembly is the most efficient scraping system we have ever manufactured! (See figure 1) Each scraper blade is pushed against the cylinder wall by three (24 quart) or two (12 quart) stainless steel springs per scraper blade. As the blades wear, the scraping action continues as it did when the machine was new. We anticipate that under normal use your scraper blades will last 5 years or longer.

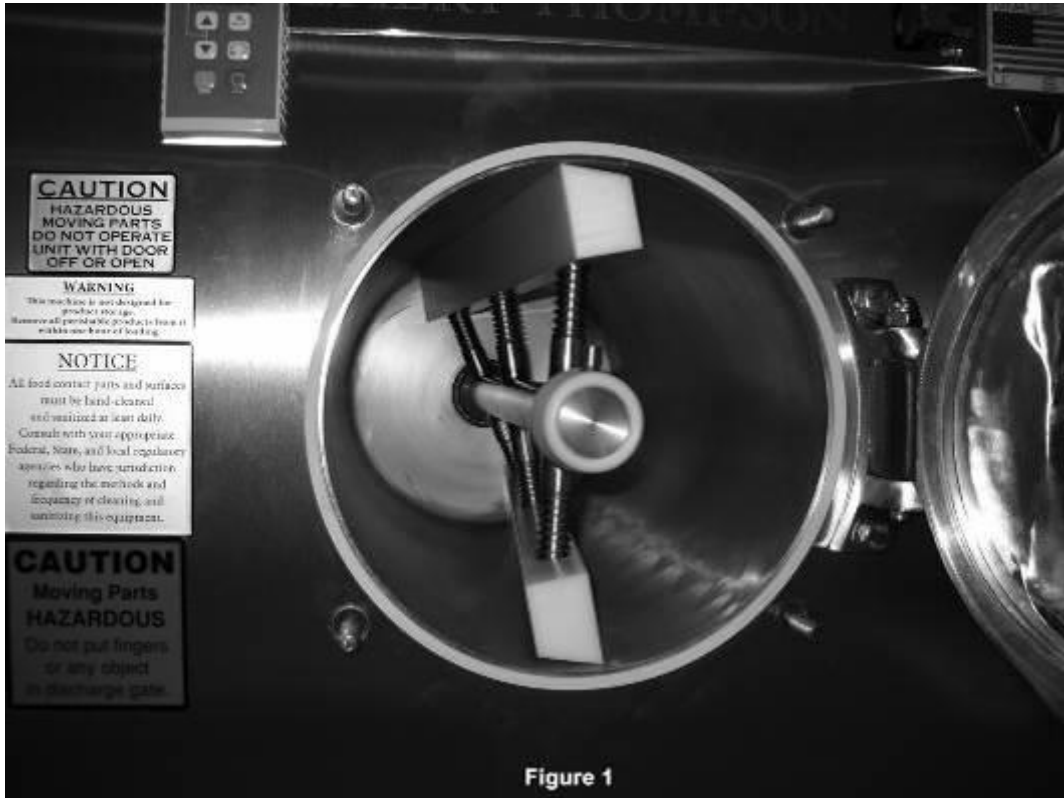

It is important that the scraper blades be installed properly – see figures 2 and 3. When installing the blades on the dasher, the curved end of the blade goes to the back of the machine. Note: if your machine is three phase power, check that the rotation is *counter-clockwise*.

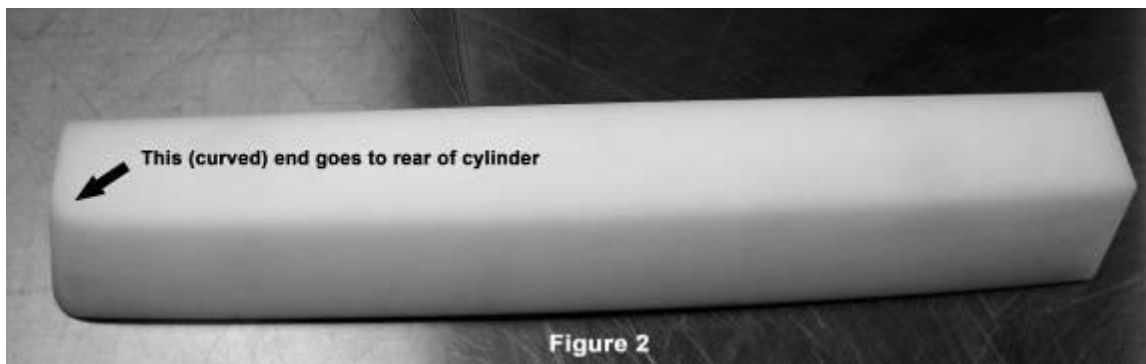



Center Shaft



Figure 3

The center shaft at the very back of the cylinder must be lubricated every day of operation, or at least every 8 hours of operation, with a food grade lubricant such as Lubri Film or Petro Jel. Apply a generous amount of lubricant to the o-ring area and center shaft. When you insert the drive shaft in the back-jacket bushing, the excess lubricant will be pushed forward into the cylinder which you can wipe off with a paper towel.

After you install the dasher, turn it by hand at least $\frac{1}{2}$ of a revolution to ensure that it is seated properly in the center shaft. All parts of your Emery Thompson fit perfectly so do not force any parts. If you have any questions, please don't hesitate to call us at (718) 588-7300.

INFINITE OVERRUN CONTROL

The Infinite Overrun Control is our latest technology designed to give you the finest possible artisan gelato, old-fashioned super-premium hard ice cream, sorbet, sherbet, sorbetto, frozen custard, frozen lemonade, frozen yogurt and Italian ice.....all in one machine!

All of these products have different air contents, or as the dairy industry calls it: "overrun". Gelato has the lowest air content of any dairy product and thus it is produced at a lower beater speed - usually around 140 rpm's. Water ices, which have no dairy product in them and won't take on much air, are run at a high speed of around 234 rpm's. All of the other products that your Emery Thompson can produce fall within this range.

Our I.O.C. allows you to select the product *by name* that you want to make, and will start the machine at our recommended speed, which will be displayed as rpm's. Any desired change in rpm can be made using the "up" or "down" arrows on that screen. You have full manual control of the speed in any of the "*Recipe Run*" screens. You also can choose MANUAL, and run the speed anywhere from 130 rpm's up to 234 rpm's. You are then in control! If you wish to add more speed or subtract speed while making any product, just push the up or down arrows, and the speed will change in increments of 5 rpm's per push.

The I.O.C. display will illuminate as long as power is applied to the machine. There is a safety "time-out" feature that makes the *Recipe* screens and *Recipe Run* screens revert back to the "Logo" screen after 60 seconds of no selection being made.

The normal sequence of operating the controls of the machine would be as follows:

1) Touch the BEGIN button on the *ET Logo* screen.



2) Select and touch the name of the product you wish to make. The display will change to the *Recipe Run* screen for that product, but will not start the machine.

If you advance to the Recipe Run screen to a product you didn't want, touch the STOP button to go back one screen, and make a new selection.



3) Touch the START button, and the machine will start and accelerate up to the pre-programmed speed for that product.

Remember that any desired change in rpm can be made using the "up" or "down" arrows on that screen.



4) Turn ON the refrigeration toggle switch on the right hand side of the machine. **Note that the refrigeration WILL NOT start without the beater running!**



5) When the product has frozen to the desired stiffness, immediately turn OFF the refrigeration switch, and begin to discharge the product.

6) When the product is fully discharged from the machine, close the gate, and touch the STOP button.



Cleaning and Sanitizing Your New Machine

Your new machine has been shipped from our facilities “factory fresh.” In other words, your machine is bright and shiny but still has some machining oils and polishing grit on all surfaces. It will be necessary for you to thoroughly clean your new batch freezer before you begin making ice cream or water ices.

The outside stainless steel “skin” (panels and top) of the machine should only be cleaned with a mild liquid detergent and water or other non-abrasive cleaners. Abrasive products will permanently scratch the outer skin. Stainless Steel polish can be purchased locally and will keep your machine looking factory fresh. The door, beater, barrel and drive shaft are all stainless steel and can best be cleaned with a mild scouring pad such as SOS or Brillo. **PLEASE NOTE: When working on any moving part, all electrical connections must be turned OFF.** On a new start up, care should be used to thoroughly clean the discharge gate and its channels. Used on a regular basis, these products will keep milkstone or sugar from building up. Stainless Steel can, and will, continue to look new for the life of the machine. The scraper blades should be taken apart for cleaning and can be washed in a mild soapy solution.

On a per-use basis or every eight hours of continuous operation, you must lubricate the center shaft. The shaft is located in the barrel behind the beater assembly. It is round in shape and pulls straight out from the back of the barrel. Lubricate with tube Vaseline, Petro-Jel or Taylor Lube. Apply a generous coating on to the round part of the shaft and re-insert the shaft into the back of the machine. Any excess lubricant will be pushed forward into the barrel and can then be wiped off with a paper towel.

Prior to each use your machine must be sanitized. The purpose of sanitization is to kill any bacteria that may have grown since the last time that you used the machine. Sanitizing is always done just prior to using the machine. Never leave sanitizing solution in the machine for more than ten minutes. Never sanitize longer than fifteen minutes before use of the machine. If you leave the machine alone for more than fifteen minutes – let’s say, to go to lunch, you should re-sanitize when you come back to the machine. If you open the front cover of the machine, you should re-sanitize. You can **never** be **too clean** in the dessert business!!

We strongly advise that you contact your local health department for their instructions on cleaning and sanitizing frozen dessert equipment. See "Typical Department of Agriculture Regulations" in Table of Contents for a representative example of a State's cleaning and handling guidelines.



In a clean bucket that has been set-aside just for sanitizing purposes, prepare a solution of sanitizer. A commercial sanitizer such as *Stera-Sheen* is preferred. Mix according to the manufacturer's directions and your local health inspector. Pour the sanitizing solution into the opening on the front cover. Save some of the solution to wipe down the front cover, discharge chute (10 and 20 qt. models) and the can stand. For safety and cleanliness, use disposable paper towels. With the front cover guard and lid closed, turn on the **beater switch** only. Do **not** turn on the **refrigeration** switch, as this would cause the solution to immediately freeze to the cylinder walls. Allow the beater to run for approximately five minutes or as long as your local health inspector recommends. Running longer than five minutes will cause a heat build-up and possible damage to your freezers dasher blades.

After sanitizing for approximately five minutes, **turn off the beater** and discharge the sanitizer into your clean bucket. If you attempt to discharge the sanitizer without first turning off the beater – you'll have sanitizer everywhere but in the bucket!

Note: When we make ice cream or water ices, we first turn off the refrigeration switch to stop the freezing process but leave the beater spinning to help push the product out of the machine. Water needs no such help!

CAUTION! Unapproved sanitizer or laundry bleach should not be used to clean your freezer as these materials may contain concentrations of chlorine in undetermined strengths. This could cause health hazards and possible damage to your batch freezer.

To clean the machine at the end of your production run, add *cold water* to the batch freezer and turn on only the beater switch. Run this water for a couple of minutes to warm up the freezer and loosen the remaining ice cream or ices. Then run a couple of batches of *warm water*. **DO NOT USE VERY HOT WATER** as this will damage the cylinder and void your warranty! Hot water can cause the refrigeration coils to separate from the barrel.

Typical Department of Agriculture Regulations

**PENNSYLVANIA DEPARTMENT OF AGRICULTURE
BUREAU OF FOOD SAFETY AND LABORATORY SERVICES
2301 NORTH CAMERON STREET
HARRISBURG, PENNSYLVANIA 17110-9408
TELEPHONE: (717) 787-4315**

FROZEN DESSERT MACHINE CLEANING AND HANDLING PROCEDURES

The following is condensed from the PA Frozen Dessert Law and Standards:

STEPS FOR CLEANING AND SANITIZING:

1. Thoroughly rinse all equipment used during the operation with lukewarm water approximately 90°F.
2. Completely disassemble and thoroughly scrub every part that comes in contact with the product. Use a suitable brush and dairy cleanser dissolved in hot (110°-120°F) water. The department recommends the use of a chlorinated alkaline cleaner during this step. To prevent milkstone accumulation, the Department recommends the periodic (once or twice per week) use of milkstone remover before sanitizing.
3. Rinse washed parts thoroughly with clean hot water and then sanitize.
4. Reassemble and sanitize equipment before use. Effective concentrations and temperatures of approved agents shall be used for cleaning and sanitizing, and shall be used according to manufacturer's directions.
5. Prior to use, do not handle any portion of equipment or containers that have been sanitized.

REQUIREMENTS

1. Machines shall be rinsed and disassembled after each day's use.
2. Machines shall be washed, rinsed, and sanitized before the close of each working day on which they are used.
3. Machines shall be sanitized prior to use on each day they are used.
4. Machines shall be left unassembled with adequate ventilation when not in use.

REMINDERS

1. Don't rinse the machine with tap water after sanitizing upon reassembly. Place mix in the machine immediately after sanitizing and drain off excess sanitizer.
2. Keep cleaning brushes dry and clean and use only for the frozen dessert machines.
3. Mix Handling: (a) Once the machine has been sanitized, don't touch any of those parts coming into contact with the mix. When opening mix containers, keep fingers away from the container opening and don't allow the outside of the bag to touch the interior of the machine, (b) Make sure mix is held at a temperature not exceeding 45°F both in the cooler and in the machine, as per the Frozen Dessert Regulations. Don't allow mix to sit out. (c) Check mix date codes and temperatures upon delivery.

Daily, thorough cleaning and sanitizing of all machine is the key to keeping bacteria and coliform counts to a minimum.



NOW YOU'RE READY TO MAKE SOME PRODUCT!!

1. Fill the cylinder at least half full with product - 6 quarts of mix for the 12NW/LA, 12 quarts for the 24NW/LA, and 24 quarts for the 44BLT.
2. Push the Green button or begin..
3. Push and hold the ^ up arrow until you achieve the RPM speed that you desire. You can make fine adjustments up or down at this time to reach the speed you desire.
4. Flip up the refrigeration toggle switch.
5. Set a timer for between 9 – 18 minutes depending on the product that you are making. (The higher the sugar content, the longer the product takes to freeze.)
6. When your product is frozen to a point where the discharge gate will cut it off like a knife (not oozing out) **turn off the refrigeration switch.**
7. You can now draw off the product at your selected speed **and/or** increase the speed to assist in discharging the remaining product. **CAUTION** Make certain that your safety guards are in place. Do not use sharp objects near the product inlet or outlet. **NEVER** let observers take a taste of your ice cream – they are contaminating the product and are at risk for injury.

WE HOPE YOU ENJOY YOUR NEW EMERY THOMPSON BATCH FREEZER

If you have *any* questions as to the safe operation of your machine, please don't hesitate to call us at our factory **718-588-7300**.



Making Ice Cream, Gelato, Sherbet and Water Ices

The freezing times discussed here will vary greatly due to the following conditions:

1. **The Product Being Made.** The higher the sugar content of the product, the longer it takes to freeze. Ice cream takes approximately ten minutes and water ices with a much higher sugar content will take eighteen minutes or longer.

2. **The Operator.** Everyone makes ice cream and ices differently. Thus what may take one operator nine minutes for ice cream to be “ready” may take another operator eleven minutes. Do not be overly concerned if your freezing times vary somewhat from the norm.

3. **Condition of the Blades.** Under normal conditions your scraper blades need to be “re-sharpened” by Emery Thompson once a year. Re-sharpening is a bit of a misnomer as the blades become ragged and uneven as they wear. A well-sharpened blade is actually dull. As time wears on and your blades become rough, your freezing time will slowly increase until you finally notice something is wrong.

WARNING! Putting undissolved sugar directly into your machine will quickly ruin the edge of your scraper blades and cause premature wear. You must dissolve the sugar in water before putting it into the batch freezer.

4. **Continuous Batches.** If you make batches one after another (without rinsing) your first batch will be about a minute longer than subsequent batches. However, if you make two, five or more batches one after another, your freezing time will **not** continue to drop.

Making Ice Cream and Gelato

Add half the capacity of mix into the machine. i.e. if you have a twenty-quart or five gallon batch freezer, add two and a half or ten quarts of mix into the freezer. Any and all flavors, fruits, nuts, cookies etc. can be added at this time. Or, to keep nuts from being broken up, add them approximately three minutes into the batch.

Turn on the beater switch and then the refrigeration switch. Do not turn on both switches at once as this can cause a power surge that might trip the breaker at your breaker box. Freeze the ice cream for approximately eight minutes. Ice cream is ready when you can open and quickly close the discharge chute and the ice cream cuts off like a knife went through it. If the ice cream oozes out of the discharge chute – it’s not ready. If the ice cream won’t flow out easily – it’s over frozen.



When the ice cream is ready on a single speed machine the overrun will be about 70%. To obtain a higher overrun, turn off the refrigeration switch and let the beater continue to run for 30 seconds to a minute and then discharge the ice cream.

Plan your ice cream production – strawberry, Bordeaux cherry, black raspberry – so that the darker flavor will cover over the lighter flavor. In this manner you won't have to rinse the machine after every flavor.

Water Ices

Also known as Italian ices, frozen lemonade, sorbet, sorbetto can be produced in your batch freezer in approximately 18 – 20 minutes. Water ices are the consistency of wet cement when they are ready to come out of the machine. Your Emery Thompson is built to take this kind of load!

Mix cold water and sugar in a bucket (not in the batch freezer) and pour into the cylinder. Add natural flavors, bases or extracts and start the freezing process. Water ices, with a higher sugar content than ice cream and Gelato will take longer to freeze. Note: if your water ice formula has too little sugar in it, you will hear banging in the cylinder as the product freezes to the walls of the barrel. You must increase the sugar content of your formula. Water ices have almost no air in the product. Therefore, the mixture you pour into the freezer should be approximately $\frac{3}{4}$ the finished capacity of the machine and the yield will be the capacity of the machine. Example: In a 20qt. batch freezer, you add approximately 17 quarts of liquid and your yield is 20 quarts.

Frozen Custard

10-12% is the maximum butterfat that is found in custard. The air content (overrun) of custard is very low. If you have the I.O.C. feature on your batch freezer you can produce a very good custard in large quantities. Custard is run the same as Gelato.

Sherbet

Sherbet is a cross between water ices and ice cream. It is a water ice formula with the addition of ice cream mix. The approximate freezing time of sherbet is 12 – 15 minutes.

Call us if you need any assistance with formulas or the operation of your machine! 718-588-7300



Steve Thompson's

“SECRET”

ITALIAN ICE FORMULA

6 -8 POUNDS SUGAR

14 QUARTS COLD WATER

2 - QUARTS FRESH SQUEEZED LEMON JUICE

6 California lemons - grated

mix the sugar and water in a bucket until dissolved.

add to the emery thompson 24 quart batch freezer
add the lemon juice and the lemon zest

freeze for 16 - 18 minutes depending on the sugar content used (MORE SUGAR, LONGER FREEZING TIME)

SERVE AND STORE AT 16 DEGREES F.



CARE AND MAINTENANCE

ALWAYS USE THE SAFETY GUARDS THAT CAME WITH YOUR MACHINE! THEY ARE THERE FOR YOUR PROTECTION AND THE PROTECTION OF YOUR EMPLOYEES.

In a perfect world Emery Thompson Co. would weld the panels closed to our machines and tell you “no maintenance for the next thirty years.” Although we have come very close to that goal, we’re not quite there yet!

First, let’s look at what you don’t have to do. If your machine was built after January of 1994, you don’t have to change the oil in the transmission (also known as the speed reducer). It’s filled with synthetic oil and a bellows has been attached to keep the operating temperatures down. Don’t worry about the drive belts – they’re steel reinforced and last an average of twelve years. If they do start to squeal after many hours of operation, try a little belt dressing – sold at automotive supply stores. How about the Freon in the compressor? It doesn’t wear out and it shouldn’t leak out.

Another maintenance point is the center shaft. This, as in all freezers, needs to be lubricated with petroleum jelly (Petro-Jel, Taylor Lube, Lubri-film) on a daily basis or every eight hours – whichever comes first. We do have customers that run their machines round the clock and break down and reassemble every eight hours.

On the drive shaft are two “O” rings on the 12, 24 and 44 quart models. On the older 44 quart models there is one “O” ring and one “V” seal. These need to be changed approximately once every two years. Simply roll off the old ones and roll on the new ones.

A well-maintained machine should not need milkstone remover. But if your want to shine up the barrel, the beater or the front cover, just use a scouring pad like SOS or Brillo. Other than that there isn’t much else to do. You can keep the stainless steel skin in new condition with mineral oil, stainless steel polish or window cleaner.

With just these few maintenance tips, you too should expect 40 or more years of trouble free life out of your Emery Thompson Batch Freezer.



Routine Maintenance of Your Emery Thompson

One of the many reasons you purchased your Emery Thompson Batch Freezer was that you heard that almost nothing goes wrong! And with some very simple routine maintenance that will be true for your freezer too! We have been building Batch Freezers for over 103 years and as such have heard every conceivable maintenance question. Please don't hesitate to call our factory @ 718-588-7300 whenever you have a question.

One key item to remember about your new Emery Thompson freezer – **Every part fits perfectly! If you are having trouble assembling a part – you are not assembling the machine in a correct fashion! Do not force parts!**

LUBRICATION

1. On a daily basis or after an eight-hour shift, you must lubricate the center shaft. The center shaft is in the back of the barrel and pulls straight out. It consists of round stainless steel bar stock and a square end piece. Only the round area needs to be lubricated. Petroleum jelly is the generic lubricant. This is available as Vaseline, Petro-Jel and Taylor Lube. Health departments recommend that you purchase these products in a tube so that you will not contaminate the rest of the product by putting your finger into a jar. Put a generous amount on to the shaft and then place the shaft back in the rear bearing. Any excess lubricant will be pushed forward into the cylinder and can be wiped off with a clean towel.
2. Do not lubricate the front white bearing, as Delrin is a self-lubricating plastic. Do not lubricate the front cover (door) gasket, as it will not stay on the machine if you do.
3. The drive motors are sealed and do not need lubrication.
4. The compressor contains oil mixed with refrigerant and should not need any additional lubricant.
5. The speed reducer is filled with Mobil 1 (SCH 630) synthetic oil and does not require maintenance for many years. Please note: the speed reducer is a miniature transmission and it is normal for it to run *very hot!* With normal usage you may want to replace the speed reducer oil in about five years. Call our factory for instructions on how to replace the speed reducer oil.
6. The drive belts of course do not require lubrication and last on average ten years. However, if your belts develop a squeak you can spray them with a product available at an automotive supply store called “Belt Dressing.”



THE DASHER (beater)

1. Emery Thompson Batch Freezers built after 1995 have a cast stainless-steel dasher and thus require **no maintenance!** Dashers built prior to 1995 were made of a stainless material called Dairy Metal. Dairy Metal is soft and can be twisted out of shape. Also the blade pins can, in time, loosen. Call our factory for maintenance tips if you have purchased an older machine with a Dairy Metal Dasher.
2. Making ice cream or water ices is the consistency of wet cement. Do not stop the dasher while making product. If you “freeze up” the machine because you left it alone and the thermal protection (overloads) cut off the machine, do not merely push the reset button and allow the oversized drive motor start up the dasher and mass of ice cream or ices. Turn off ALL the switches, disconnect all the power, open the door and remove the product and dasher by hand. With all the torque coming from the back of the machine, failure to time your batches correctly could strain the motors and possibly break the coupling!

SCRAPER BLADES

Please see section titled "Dasher and Scraper Blades".

REAR COUPLING.

1. On the 12 and 24-quart freezers, the rear coupling is a round white piece of Delrin plastic chain with two gears inside of it, or two gears with a plastic chain over them. On the 44-quart freezer, the two gears are held together with a metal chain. This coupling connects the drive shaft to the speed reducer. It is designed to be loose and wiggle. If you freeze up the machine and then restart as described above, you will break the coupling *instead* of breaking the more expensive speed reducer! If you break this part we can sell you a new one and have it delivered to you overnight. DO NOT leave your machine while you are making ice cream or ices! (See "**Removing/Replacing the Complete Coupling**" below.)

MISCELLANEOUS PARTS.

1. Front cover gasket. These last about three years but then stretch out of shape. They are easy to change – if you don't lubricate it!
2. Gate springs. The gate springs hold the gate in place and help to form a seal and will last about four years. If the gate and the springs lose their tension and product leaks, it's time to replace the gate springs.
3. "O" rings. There are two black "O" rings on the drive shaft of the 12, 24 and 44 quart models that should be replaced on average, every two years. If you see mix on the floor, it's time to replace the "O" rings. On the older 44 quart models there is one "O" ring and one "V" seal that should be replaced.

Please call our factory at 718-588-7300 and we can explain in further detail how to replace these parts.

12 and 24 QUART MACHINES

REMOVING / REPLACING THE COMPLETE COUPLING*

NOTICE – WE NO LONGER SELL THE NYLON SPLINED SLEEVE COUPLING OR THE COUPLING WITH THE PIN WITH THE E-CLIP RETAINER. ALL NEW COUPLINGS WILL HAVE PRESS-FIT PINS.

REMOVAL:

- 1) Disconnect power to the machine.
- 2) Remove the dasher and the center shaft.
- 3) Remove the top lid.
- 4) Remove the plastic Delrin chain (or the nylon splined sleeve, depending on the age of your machine) and the square-bored drive sprocket. A damaged coupling will have one or more of the following issues: a) a broken or cracked plastic chain, b) a broken or cracked nylon splined sleeve, c) a stripped-out nylon splined sleeve, d) a broken or cracked square-bored drive sprocket, or e) a broken or cracked speed reducer output shaft coupling sprocket.
- 5) Loosen and remove the two set screws in the speed reducer output shaft coupling sprocket. Spray penetrating lubricant into both set screw holes, and around the shaft on both sides of the sprocket.
- 6) To remove the speed reducer output shaft coupling sprocket, tap around the backside of the sprocket in several places with a small hammer until it is driven off the shaft. If the sprocket won't come off by tapping with a hammer, insert a wooden block and a tapered chisel between the face of the speed reducer and the face of the sprocket hub. Tap firmly on the end of the chisel with a hammer and the sprocket should slide off the shaft.



REPLACING:

- 1) Carefully inspect the speed reducer output shaft and its keyway. Both must be free of rust, scale, and burrs. The old key can be used over in the new installation, but again - check its condition - it may need cleaning and/or filing. Regardless if you use the old key or a new one, it must fit into the keyway on the speed reducer shaft. Insert it into the keyway, flush to the end of the shaft.
- 2) The speed reducer output shaft coupling sprocket is the one with the round bore. The toothed side of the sprocket will face the freezing cylinder of the machine (NOT THE SPEED REDUCER). Be sure that both set screws are backed far enough out of the sprocket that they don't make contact with the shaft while sliding the sprocket into position.
- 3) Lubricate the bore of the sprocket and the speed reducer shaft, and start the new sprocket onto the shaft, lining up the keyway in the sprocket to the key. It may be necessary to tap the sprocket onto the speed reducer. If it cannot simply be tapped on, take it back off, and carefully sand/file the shaft until the sprocket can be tapped on. Set the sprocket deep enough onto the shaft so that the end of the shaft is flush with the face of the sprocket. Do not tighten the set screws yet!
- 4) Remove any link pin from the new plastic chain by pressing the pin out of the link with a pin punch, or something similar, like a nail. Hold the square-bored sprocket in place and wrap the chain around both sprockets. Make sure the chain meshes with the teeth on both sprockets and wraps all the way around until the two end links align, and the link pin can be inserted through the two links.

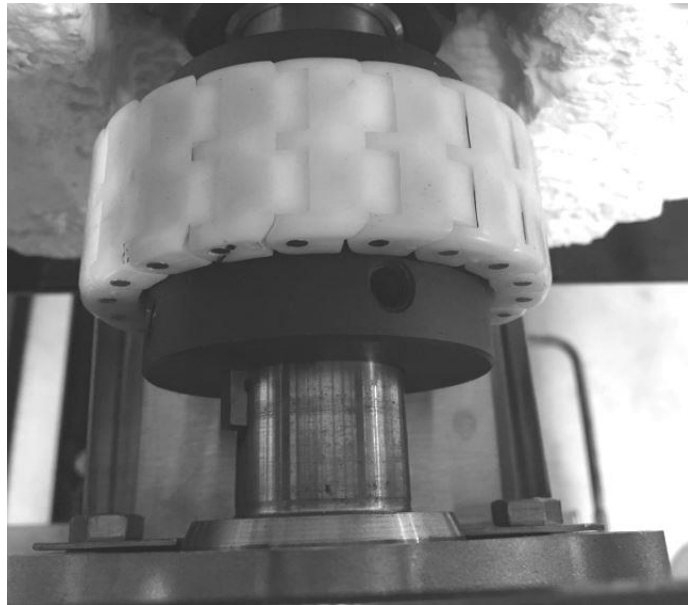
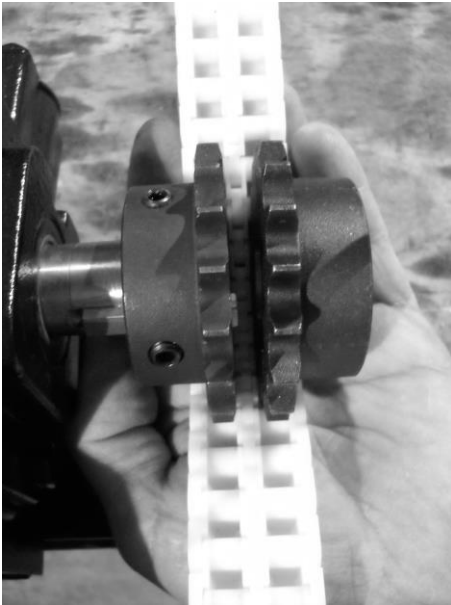

5) Before tightening the set screws in the speed reducer output shaft coupling sprocket, be sure to check and set the gap between the face of the center shaft and face of the square-bored drive sprocket. Refer to the photo below, making sure that the center shaft is pushed back as far as it will go. There should be between 1/16" and 1/8" of a gap between the shoulder of the center shaft and the face of the coupling sprocket. Once this gap is correct, tighten both set screws.

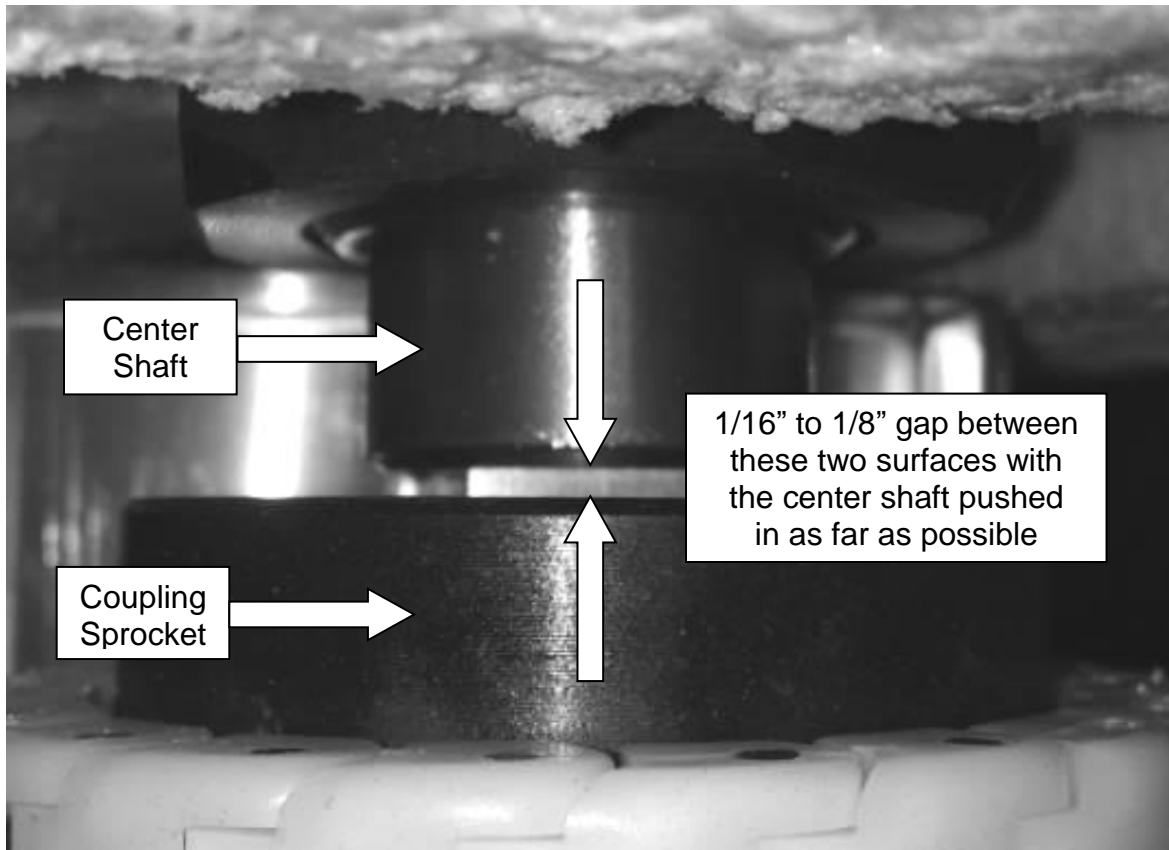

6) With the installation now complete, clean and grease the o-ring area of the center shaft prior to final assembly.

This coupling, which connects the center shaft (at rear of cylinder) to the speed reducer, is designed to last the life of your machine. However, as a safety feature this coupling will break if excessive torque is applied to the center shaft. This will occur if the machine is operated incorrectly and the product in the cylinder is allowed to over-freeze; e.g. If a batch of product is started freezing and the machine is left unattended and allowed to run indefinitely, the product will eventually freeze solid causing the dasher to stop spinning and break the coupling. Never run your machine unattended!



GASSES AND SETTINGS

REFRIGERANT:

12 QUART And 24 QUART	R-404A	8 Pound Charge – for water cooled 5.5 lbs. – for air cooled
44 QUART	R-404A	10 Pound Charge – for water cooled

PRESSURE SETTINGS

High side running pressure: 325 for our air-cooled machines

High side running pressure: 235 to 270 psi for water-cooled machines

Low side running pressure at start 50
at end 30

High/Low pressure switch – (Factory set, do not change) cut in: 40 psi
(Factory set, do not change) differential: 30 psi
(Factory set, do not change) high limit: 400 psi

Water temperature/flow – (Factory set, do not change)
Approximately 1.6 gpm @ 108° F for 12/24 Quart Machinery
Approximately 2.0 gpm @ 115° F for 44 Quart Machinery

WATER TEMPERATURE

The water being discharged by the machine (water cooled unit only) should be approximately 108° degrees F. for 12/24 Quart machines and approximately 115° F for 44 Quart machines while the machine is in production. The water valve was factory set but, due to on-site water supply variations, *might* require some minor adjustment. However, since the water valve is self-adjusting according to your inlet water temperature at the time of production, we would advise not adjusting the valve unless you talk to our technicians or a qualified refrigeration specialist *first*.



IF YOU NEED TECHNICAL ASSISTANCE

Your new Emery Thompson Batch Freezer requires only minimal service for the first ten years! We advise customers that other than re-edging the blades, there is no service needed on an Emery Thompson Batch Freezer for the first ten years.

If you have a question regarding the proper operation of your new machine, please call our factory at **718-588-7300** or **813-862-2776** and we will walk you through your problem. A typical service call is someone left the sugar out of the Italian Ice formula, the water supply to the machine was accidentally turned off, a thunderstorm tripped the circuit breaker or the machine has been moved to where the flexible water line is being crushed by a wheel. If you need an in store service call, we will arrange that for you.

If you have a technical problem after business hours, on a weekend or a holiday that cannot wait until the next business day **please call our factory at 718-588-7300 and leave a message.** It will be sent directly to our president, Steve Thompson. We are serious about your business and the investment you have made in your new Emery Thompson!"

Replacement Part Numbers and Diagrams

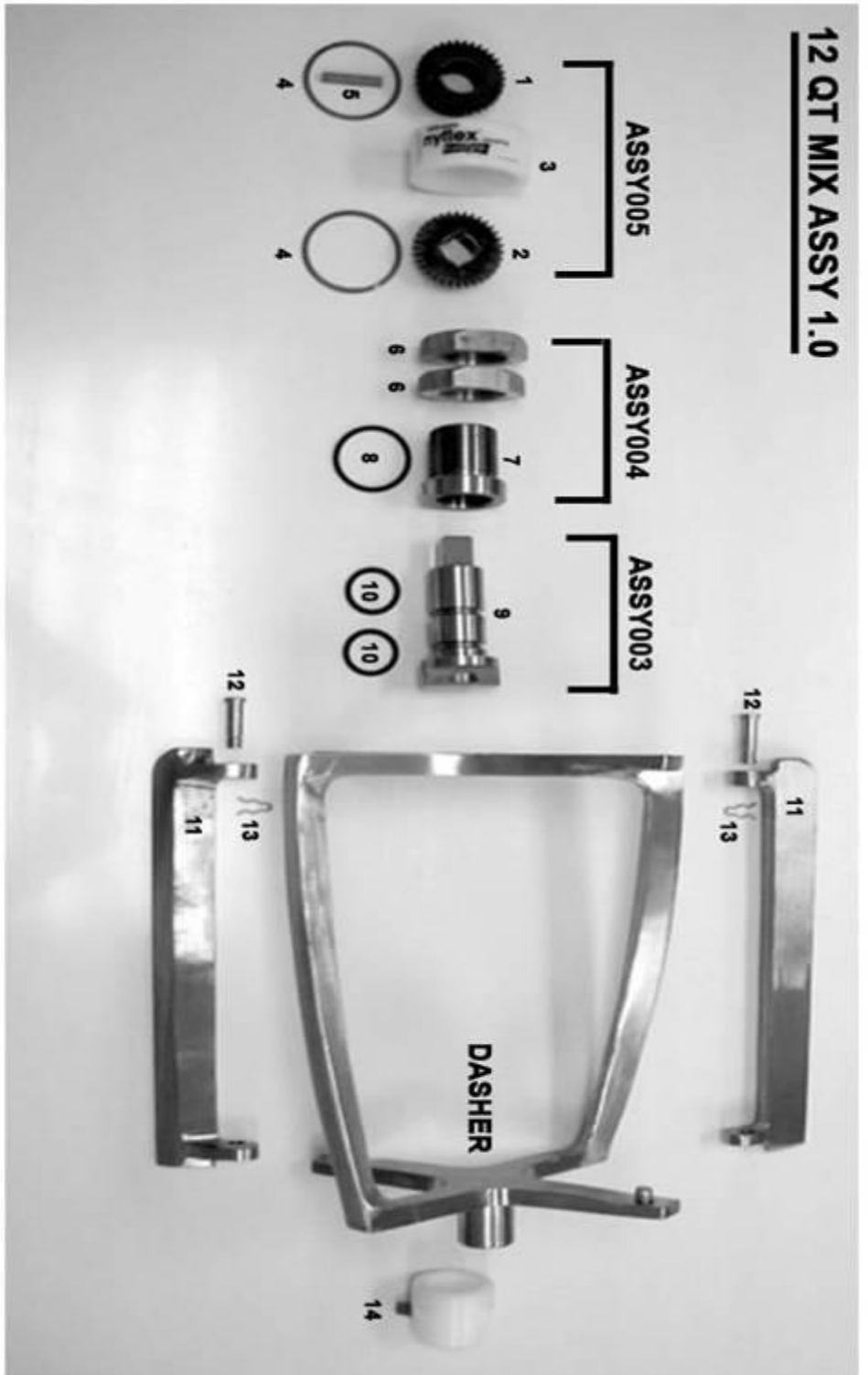

ASSY003	kit, 12 and 24 quart centershaft replacement	11	BLADD009	blade, 12 quart, solid cast stainless (2X PER MACHINE)	
ASSY004	kit, 12 and 24 quart back jacket bushing replacement	12	FAST001	pin, blade holder, 12/24 quart machines (2X PER MACHINE)	
ASSY005	kit, 12 and 24 quart coupling replacement	13	FAST003	clip, bladeholder pin, 12/24 quart machines (2X PER MACHINE)	
1	COUP001	hub, speed reducer side, 12 and 24 quart coupling	14*	BUSH001	bushing, dasher front, 1 1/2" long (* SEE NOTE BELOW)
2	COUP002	hub, centershaft side, 12 and 24 quart coupling	14*	BUSH002	bushing, dasher front, 1 9/16" long (* SEE NOTE BELOW)
3	COUP003	sleeve, splined for 12 and 24 quart coupling	14*	BUSH003	bushing, dasher front, 1 5/8" long (* SEE NOTE BELOW)
4	COUP004	snap rings, internal, for 12/24 qt coupling (2X PER MACHINE)	14*	BUSH004	bushing, dasher front, 1 11/16" long (* SEE NOTE BELOW)
5	MECH004	key, 1/4" square	14*	BUSH005	bushing, dasher front, 1 3/4" long (* SEE NOTE BELOW)
6	FAST007	nut, 12 and 24 quart back jacket bushing retaining	14*	BUSH006	bushing, dasher front, 2" long (* SEE NOTE BELOW)
7	BUSH007	bushing, back jacket, 12 and 24 quart			
8	SEAL005	o-ring, 12 and 24 quart and CB350 back jacket bushing			
9	MECH002	centershaft, 12 and 24 quart, fabricated			
10	SEAL004	o-ring, 12 and 24 quart centershaft (2X PER MACHINE)			

* CUSTOMER MUST MEASURE LENGTH TO DETERMINE CORRECT BUSHING



12 QT MIX ASSY 1.1

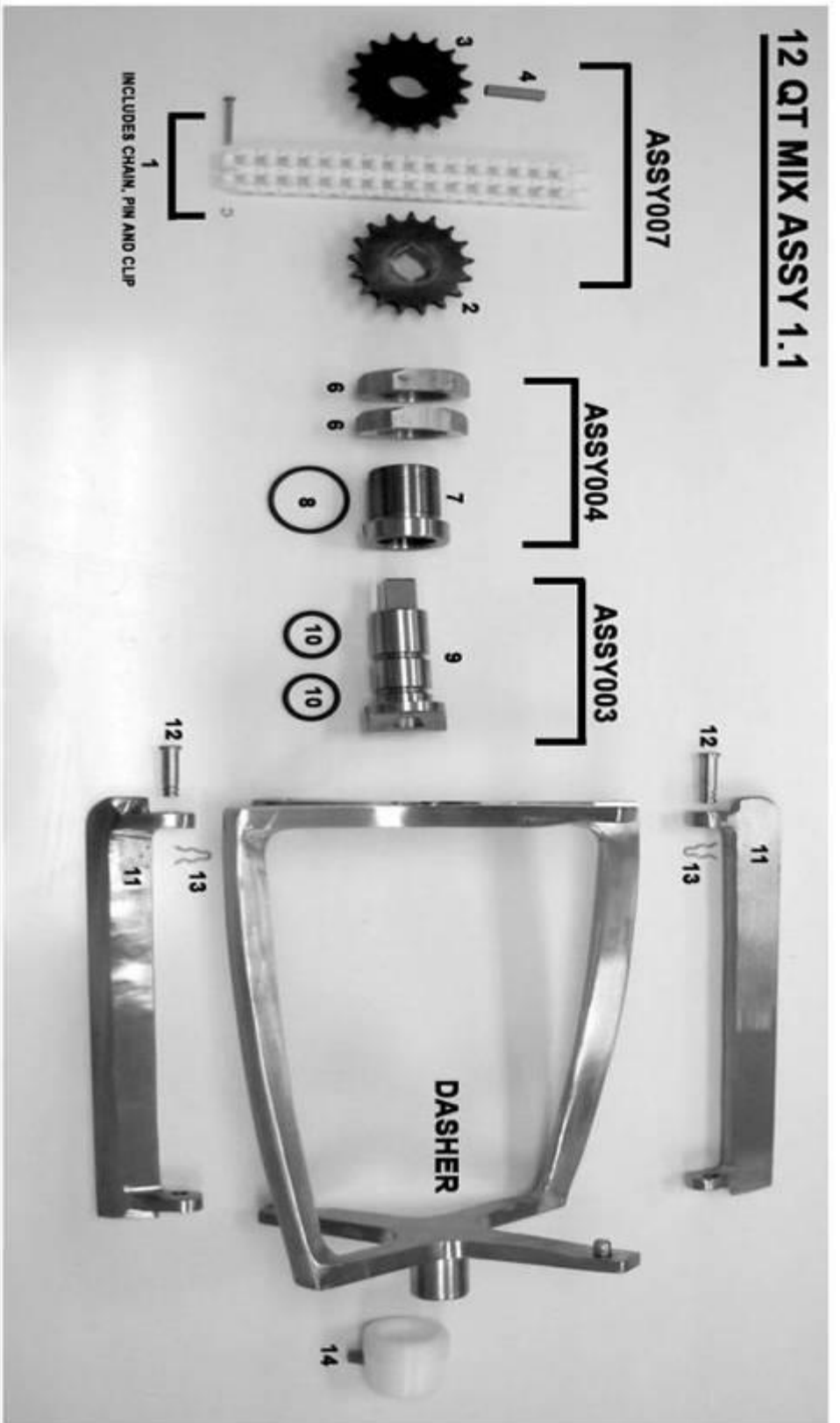

ASSY003	Kit, 12 and 24 quart <u>gentshaft</u> replacement	11	BLAD009	blade, 12 quart, solid cast stainless (2X PER MACHINE)	
ASSY004	Kit, 12 and 24 quart back jacket bushing replacement	12	FAST001	pin, blade holder, 12/24 quart machines (2X PER MACHINE)	
ASSY007	Kit, 12 and 24 quart coupling replacement, new-style	13	FAST003	clip, blade holder pin, 12/24 quart machines (2X PER MACHINE)	
1	COUP005	chain, new-style 12 and 24 quart coupling	14*	BUSH001	bushing, dasher front, 1 1/2" long (* SEE NOTE BELOW)
2	COUP007	sprocket, <u>gentshaft</u> side, new-style 12/24 quart coupling	14*	BUSH002	bushing, dasher front, 1 9/16" long (* SEE NOTE BELOW)
3	COUP006	sprocket, speed reducer side, new-style 12/24 quart coupling	14*	BUSH003	bushing, dasher front, 1 5/8" long (* SEE NOTE BELOW)
4	MECH004	key, 1/4" square	14*	BUSH004	bushing, dasher front, 1 11/16" long (* SEE NOTE BELOW)
5		NOT USED	14*	BUSH005	bushing, dasher front, 1 3/4" long (* SEE NOTE BELOW)
6	FAST007	nut, 12 and 24 quart back jacket bushing retaining	14*	BUSH006	bushing, dasher front, 2" long (* SEE NOTE BELOW)
7	BUSH007	bushing, back jacket, 12 and 24 quart			
8	SEAL005	o-ring, 12 and 24 quart and CB350 back jacket bushing			
9	MECH002	<u>gentshaft</u> , 12 and 24 quart, fabricated			
10	SEAL004	o-ring, 12 and 24 quart <u>gentshaft</u> (2X PER MACHINE)			

* CUSTOMER MUST MEASURE LENGTH TO DETERMINE CORRECT BUSHING



12 QT MIX ASSY 2.0

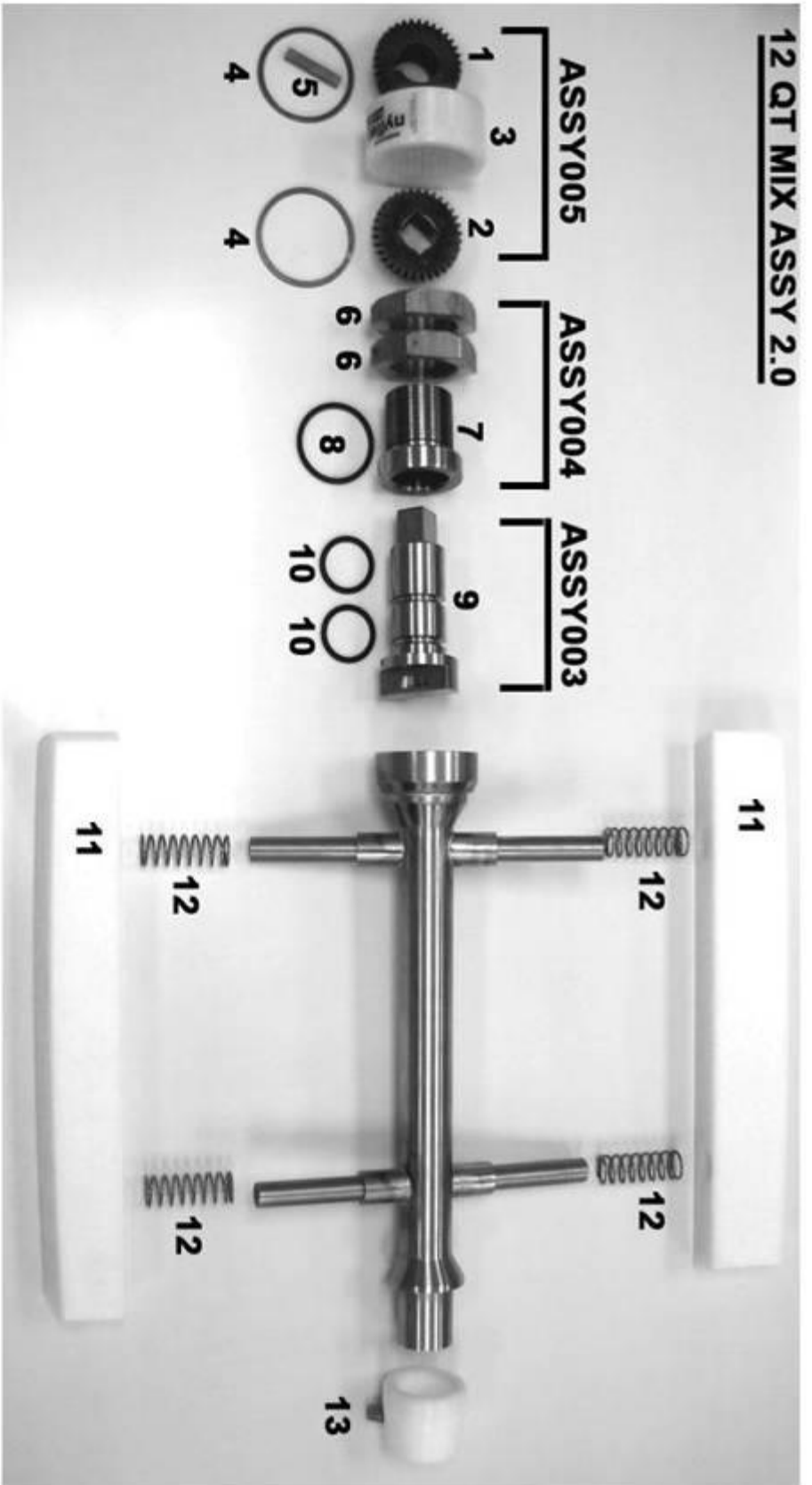

ASSY003	kit, 12 and 24 quart centershaft replacement	11	BLADD002	blade, solid Delrin, 12 quart machines (2X PER MACHINE)
ASSY004	kit, 12 and 24 quart back jacket bushing replacement	12	SPRG002	blade spring, 12 and 24 quart machines (4X PER MACHINE)
ASSY005	kit, 12 and 24 quart coupling replacement	13*	BUSH001	bushing, dasher front, 1 1/2" long (* SEE NOTE BELOW)
1	COUP001	13*	BUSH002	bushing, dasher front, 1 9/16" long (* SEE NOTE BELOW)
2	COUP002	13*	BUSH003	bushing, dasher front, 1 5/8" long (* SEE NOTE BELOW)
3	COUP003	13*	BUSH004	bushing, dasher front, 1 11/16" long (* SEE NOTE BELOW)
4	COUP004	13*	BUSH005	bushing, dasher front, 1 3/4" long (* SEE NOTE BELOW)
5	MECH004	13*	BUSH006	bushing, dasher front, 2" long (* SEE NOTE BELOW)
6	FAST007			
7	BUSH007			
8	SEAL005			
9	MECH002			
10	SEAL004			

* CUSTOMER MUST MEASURE LENGTH TO DETERMINE CORRECT BUSHING



12 QT MIX ASSY 2.1

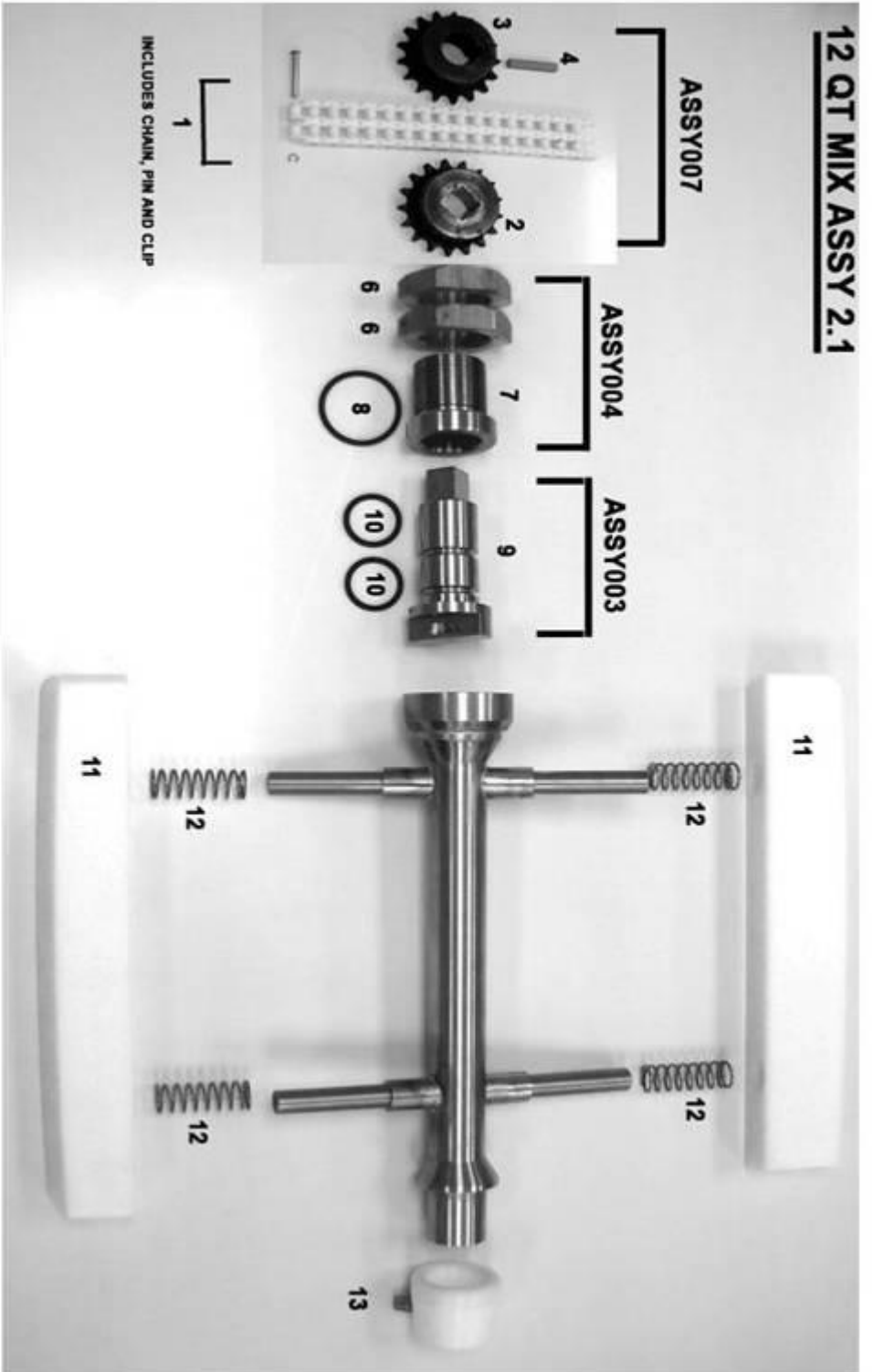

ASSY003	kit, 12 and 24 quart <u>centershaft</u> replacement	11	BLADD002	blade, solid Delrin, 12 quart machines (2X PER MACHINE)
ASSY004	kit, 12 and 24 quart back jacket bushing replacement	12	SPRG002	blade spring, 12 and 24 quart machines (4X PER MACHINE)
ASSY007	kit, 12 and 24 quart coupling replacement, new-style	13*	BUSH001	bushing, dasher front, 1 1/2" long (* SEE NOTE BELOW)
COUP005	chain, new-style 12 and 24 quart coupling	13*	BUSH002	bushing, dasher front, 1 9/16" long (* SEE NOTE BELOW)
COUP007	sprocket, <u>centershaft</u> side, new-style 12/24 quart coupling	13*	BUSH003	bushing, dasher front, 1 5/8" long (* SEE NOTE BELOW)
COUP006	sprocket, speed reducer side, new-style 12/24 quart coupling	13*	BUSH004	bushing, dasher front, 1 11/16" long (* SEE NOTE BELOW)
MECH004	key, 1/4" square	13*	BUSH005	bushing, dasher front, 1 3/4" long (* SEE NOTE BELOW)
	NOT USED	13*	BUSH006	bushing, dasher front, 2" long (* SEE NOTE BELOW)
FAST007	nut, 12 and 24 quart back jacket bushing retaining			
BUSH007	bushing, back jacket, 12 and 24 quart			
SEAL005	o-ring, 12 and 24 quart and CB350 back jacket bushing			
MECH002	<u>centershaft</u> , 12 and 24 quart, fabricated			
SEAL004	o-ring, 12 and 24 quart <u>centershaft</u> (2X PER MACHINE)			
				* CUSTOMER MUST MEASURE LENGTH TO DETERMINE CORRECT BUSHING

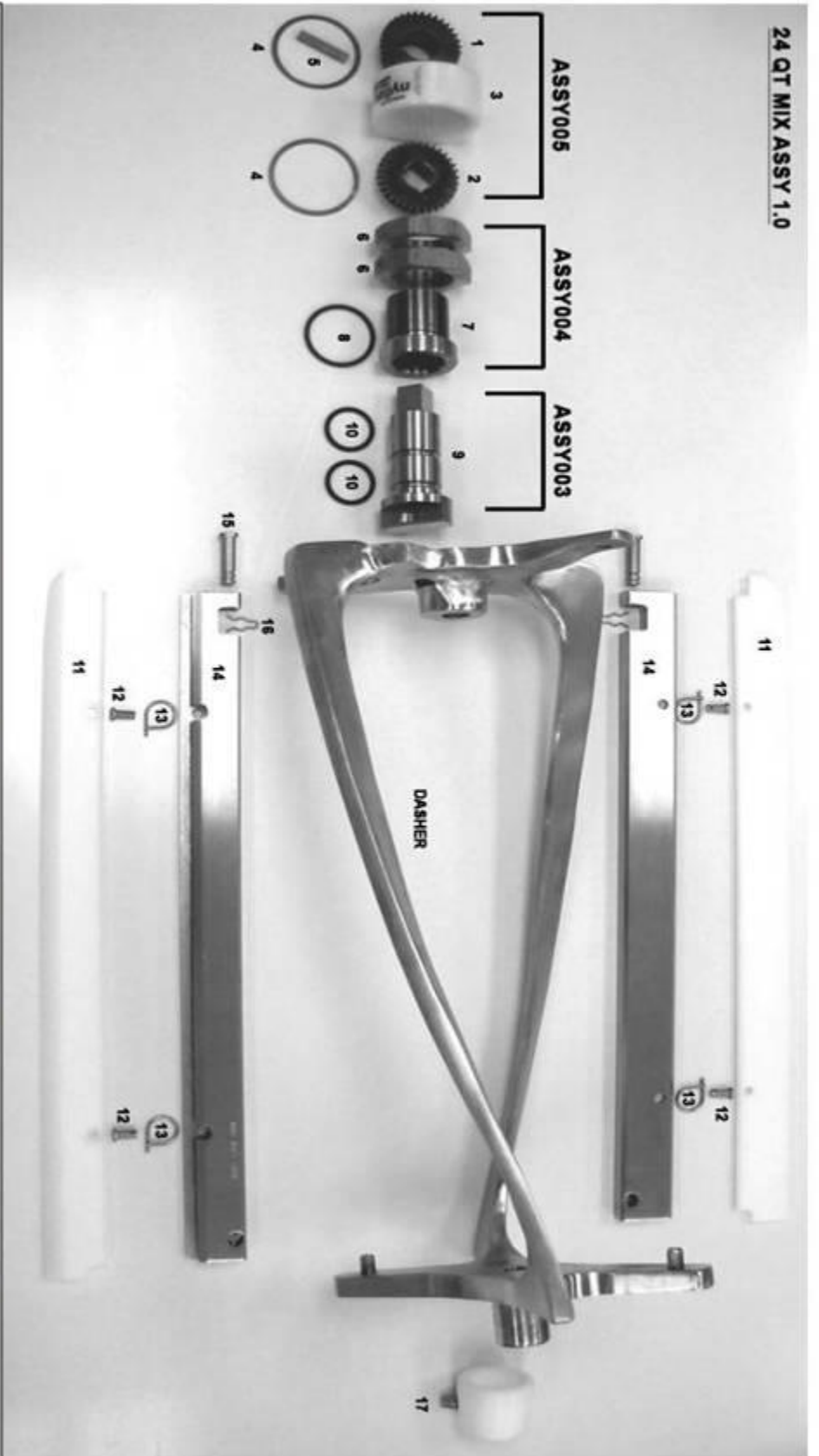

24 QT MIX ASSY 1.0

ASSY003	Kit, 12 and 24 quart centershaft replacement	11	BLAD005	blade insert, Delrin, 24 quart machines (2X PER MACHINE)	
ASSY004	Kit, 12 and 24 quart back jacket bushing replacement	12	FAST005	pin, clevis, blade insert retaining, 24/44 qt (4X PER MACHINE)	
ASSY005	Kit, 12 and 24 quart coupling replacement	13	FAST006	spring, clevis pin retaining (4X PER MACHINE)	
1	COUP001	hub, speed reducer side, 12 and 24 quart coupling	14	BLAD007	blade holder, 24 quart machines (2X PER MACHINE)
2	COUP002	hub, centershaft side, 12 and 24 quart coupling	15	FAST001	pin, blade holder, 12 or 24 quart machines (2X PER MACHINE)
3	COUP003	sleeve, splined for 12 and 24 quart coupling	16	FAST003	clip, bladeholder pin, 12/24 quart machines (2X PER MACHINE)
4	COUP004	snap rings, internal, for 12/24 qt coupling (2X PER MACHINE)	17*	BUSH001	bushing, dasher front, 1 1/2" long (* SEE NOTE BELOW)
5	MECH004	key, 1/4" square	17*	BUSH002	bushing, dasher front, 1 9/16" long (* SEE NOTE BELOW)
6	FAST007	nut, 12 and 24 quart back jacket bushing retaining	17*	BUSH003	bushing, dasher front, 1 5/8" long (* SEE NOTE BELOW)
7	BUSH007	bushing, back jacket, 12 and 24 quart	17*	BUSH004	bushing, dasher front, 1 11/16" long (* SEE NOTE BELOW)
8	SEAL005	o-ring, 12 and 24 quart and CB350 back jacket bushing	17*	BUSH005	bushing, dasher front, 1 3/4" long (* SEE NOTE BELOW)
9	MECH002	centershaft, 12 and 24 quart, fabricated	17*	BUSH006	bushing, dasher front, 2" long (* SEE NOTE BELOW)
10	SEAL004	o-ring, 12 and 24 quart centershaft (2X PER MACHINE)	* CUSTOMER MUST MEASURE LENGTH TO DETERMINE CORRECT BUSHING		

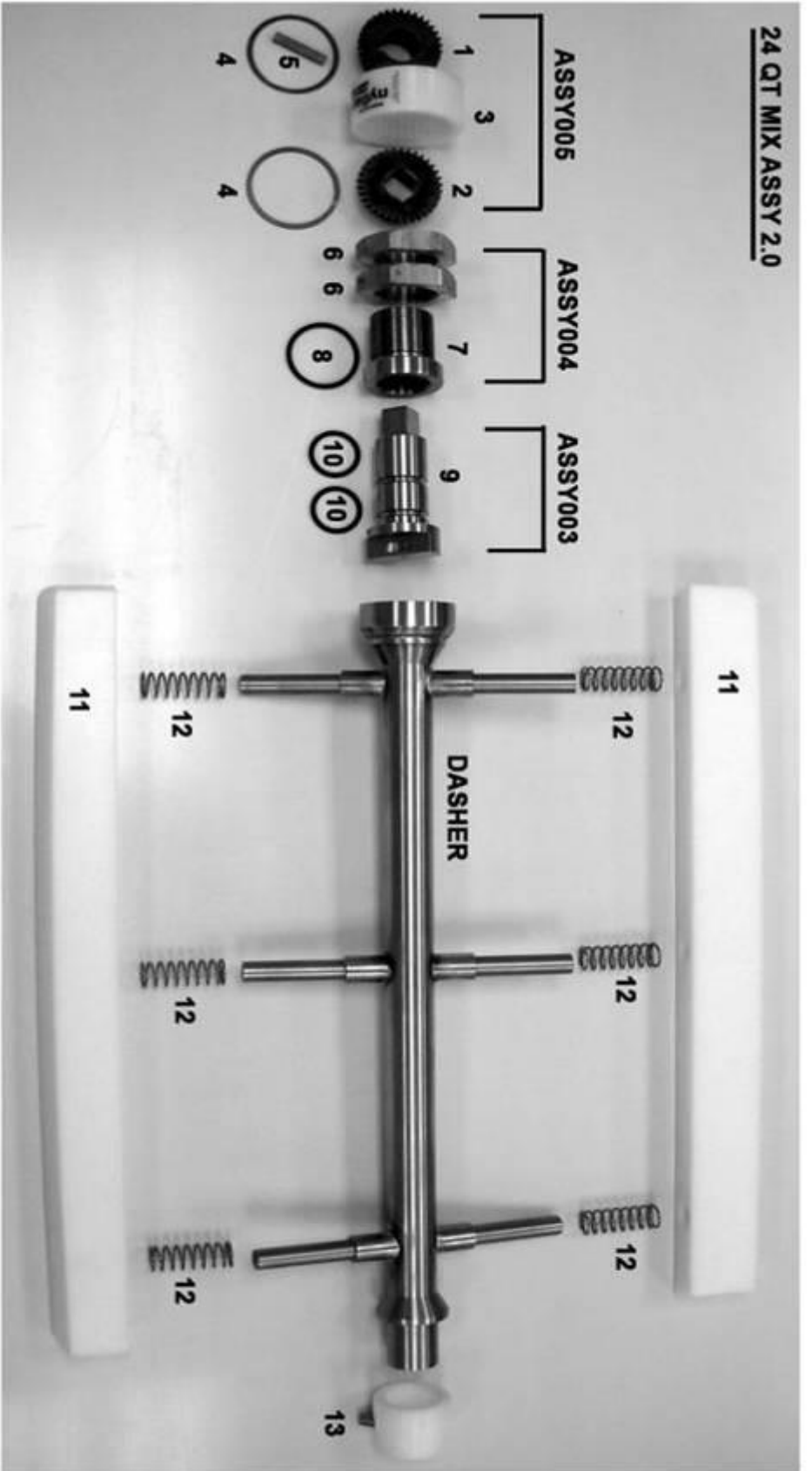

	ASSY003	Kit, 12 and 24 quart centershaft replacement	11	BLAD003	blade, solid Delrin, 24 quart machines (2X PER MACHINE)
	ASSY004	Kit, 12 and 24 quart back jacket bushing replacement	12	SPRG002	blade spring, 12 and 24 quart machines (6X PER MACHINE)
	ASSY005	Kit, 12 and 24 quart coupling replacement	13*	BUSH001	bushing, dasher front, 1 1/2" long (* SEE NOTE BELOW)
1	COUP001	hub, speed reducer side, 12 and 24 quart coupling	13*	BUSH002	bushing, dasher front, 1 9/16" long (* SEE NOTE BELOW)
2	COUP002	hub, centershaft side, 12 and 24 quart coupling	13*	BUSH003	bushing, dasher front, 1 5/8" long (* SEE NOTE BELOW)
3	COUP003	sleeve, splined for 12 and 24 quart coupling	13*	BUSH004	bushing, dasher front, 1 11/16" long (* SEE NOTE BELOW)
4	COUP004	snap rings, internal, for 12/24 qt coupling (2X PER MACHINE)	13*	BUSH005	bushing, dasher front, 1 3/4" long (* SEE NOTE BELOW)
5	MECH004	key, 1/4" square	13*	BUSH006	bushing, dasher front, 2" long (* SEE NOTE BELOW)
6	FAST007	nut, 12 and 24 quart back jacket bushing retaining			
7	BUSH007	bushing, back jacket, 12 and 24 quart			
8	SEAL005	o-ring, 12 and 24 quart and CB350 back jacket bushing			
9	MECH002	centershaft, 12 and 24 quart, fabricated			
10	SEAL004	o-ring, 12 and 24 quart centershaft (2X PER MACHINE)			

* CUSTOMER MUST MEASURE LENGTH TO DETERMINE CORRECT BUSHING



24 QT MIX ASSY 2.1

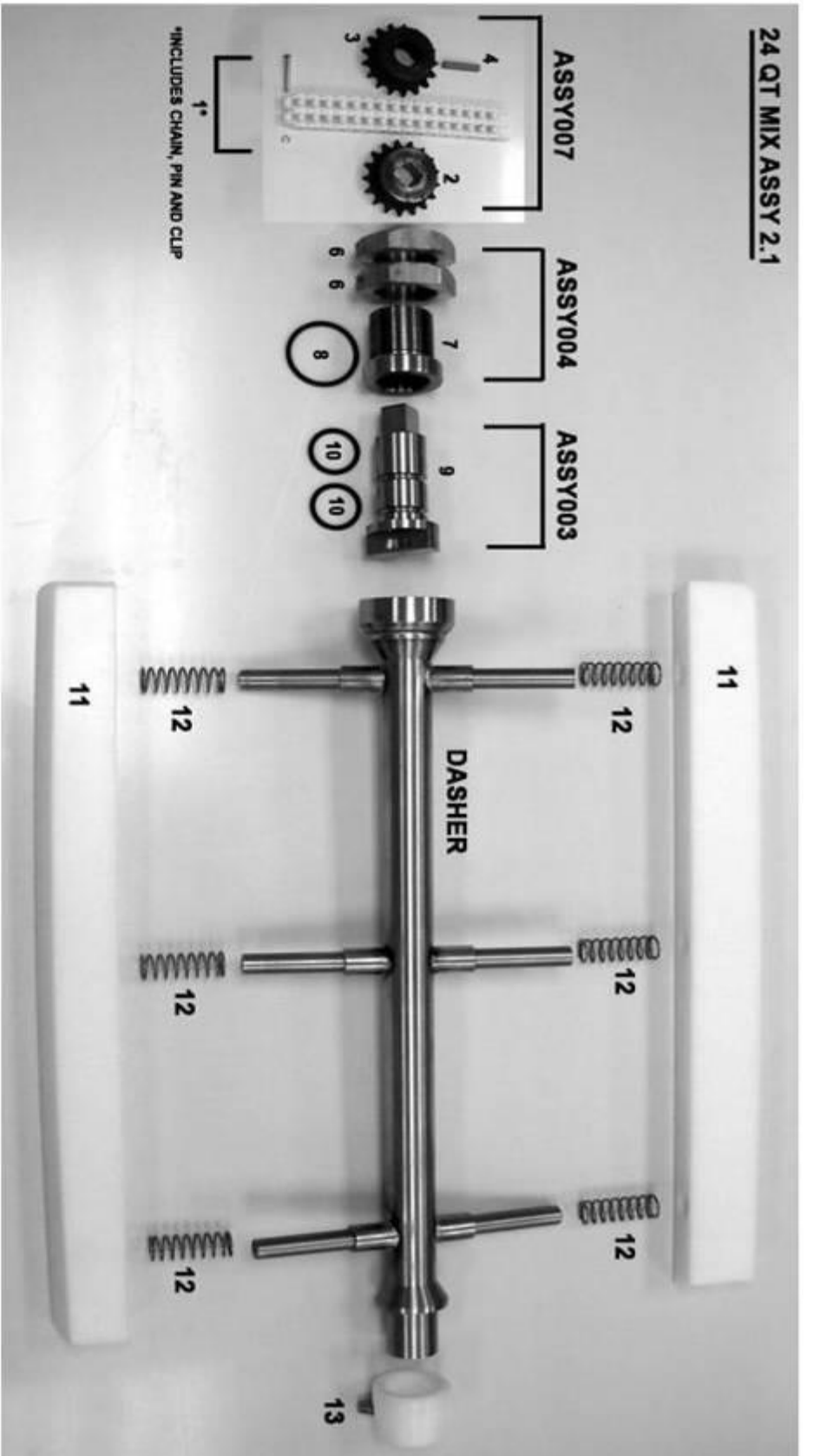

1	COUP005	chain, new-style 12 and 24 quart coupling	13*	BUSH002	bushing, dasher front, 1.9/16" long (* SEE NOTE BELOW)
2	COUP007	sprocket, gengershaft side, new-style 12/24 quart coupling	13*	BUSH003	bushing, dasher front, 1.5/8" long (* SEE NOTE BELOW)
3	COUP006	sprocket, speed reducer side, new-style 12/24 quart coupling	13*	BUSH004	bushing, dasher front, 1.11/16" long (* SEE NOTE BELOW)
4	MECH004	key, 1/4" square	13*	BUSH005	bushing, dasher front, 1.3/4" long (* SEE NOTE BELOW)
5		NOT USED	13*	BUSH006	bushing, dasher front, 2" long (* SEE NOTE BELOW)
6	FAST007	nut, 12 and 24 quart back jacket bushing retaining			
7	BUSH007	bushing, back jacket, 12 and 24 quart			
8	SEAL005	o-ring, 12 and 24 quart and CB350 back jacket bushing			
9	MECH002	gengershaft, 12 and 24 quart, fabricated			
10	SEAL004	o-ring, 12 and 24 quart gengershaft (2X PER MACHINE)			
					* CUSTOMER MUST MEASURE LENGTH TO DETERMINE CORRECT BUSHING
	ASSY003	kit, 12 and 24 quart gengershaft replacement	11	BLAD003	blade, solid Delrin, 24 quart machines (2X PER MACHINE)
	ASSY004	kit, 12 and 24 quart back jacket bushing replacement	12	SPRG002	blade spring, 12 and 24 quart machines (6X PER MACHINE)
	ASSY007	kit, 12 and 24 quart coupling replacement, new-style	13*	BUSH001	bushing, dasher front, 1.1/2" long (* SEE NOTE BELOW)



12/24 QT DOOR ASSY 1.0

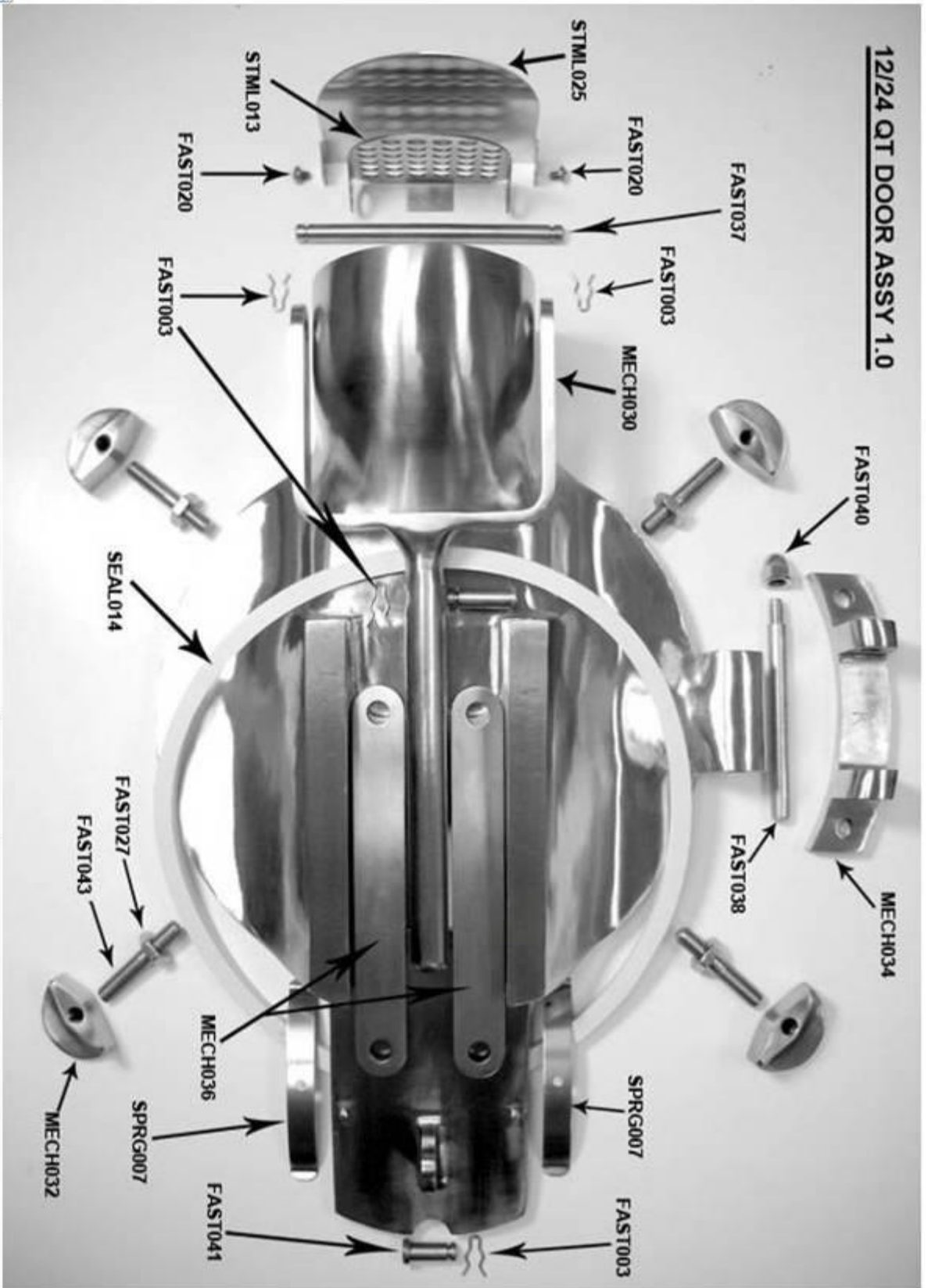

FAST003	clip, bladeholder pin, 12 or 24 quart machines (small "A")	MECH030	handle, gate operating, 12 and 24 quart
FAST020	screw, #10-24 X 1/2" long, 18-8 SS phillips head	MECH032	knob, cast 12 and 24 quart (waukeshu)
FAST027	nuts, jam 3/8"-16 18-8 ss per 10	MECH034	hinge, 12 and 24 quart (waukeshu)
FAST037	pin, handle pivot, 12, 24 and 44 qt machines, w/ groove each end	MECH036	linkage bar, 12 and 24 quart, stainless, gate-to-handle
FAST038	pin, hinge, 12 and 24 quart brass	SEAL014	door seal, 12 and 24 quart, 3/8" x 3/8" white EPDM
FAST040	nut, acorn, 3/8"-16 stainless, 12, 24 and 44 quart hinge pin top	SPRG007	spring, gate pressure, 12, 24 and 44 qt gates
FAST041	pin, handle linkage, gate end (shorter) 12, 24 and 44 quart	STML013	guard, door throat, 12 and 24 quart machines
FAST042	pin, handle linkage, handle shaft end (longer) 12, 24 and 44 quart	STML025	dust cover (lid) 12/24 qt spout opening
FAST043	stud, knob mounting, 12 and 24 quart, threaded 303 stainless, 3/8"-16		

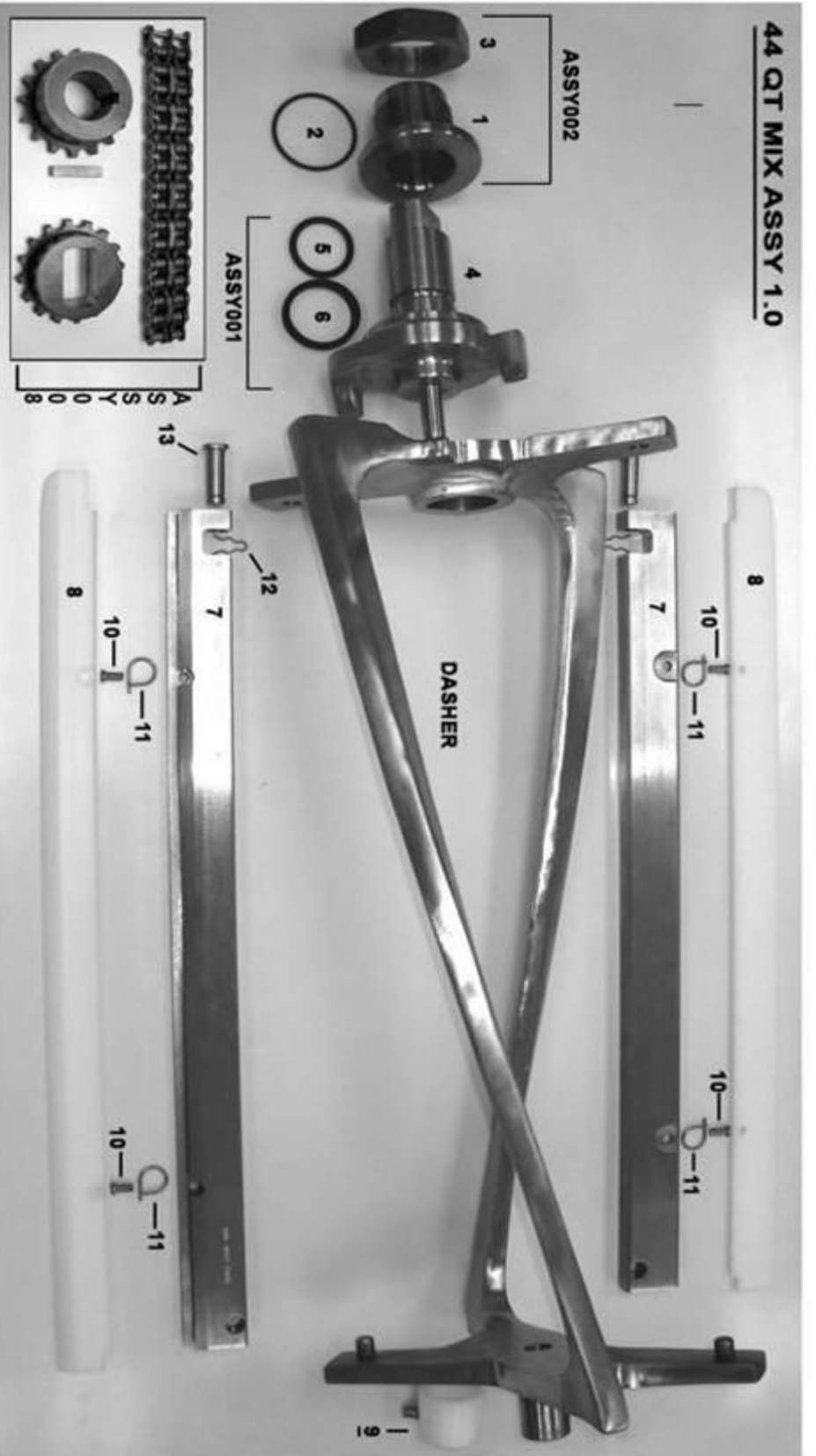

ASSY001	kit, 44 quart center shaft replacement	9*	BUSH004	bushing, dasher front, 1 1/2" long (* SEE NOTE BELOW)
ASSY002	kit, 44 quart back jacket bushing replacement	9*	BUSH005	bushing, dasher front, 1 3/4" long (* SEE NOTE BELOW)
ASSY008	Kit, 44 quart chain coupling	9*	BUSH006	bushing, dasher front, 2" long (* SEE NOTE BELOW)
BUSH008	bushing, back jacket, 44 quart	10	FAST005	pin, clevis, blade insert retaining 24/44QT (4X PER MACHINE)
SEAL003	o-ring, 44 quart back jacket bushing	11	FAST006	spring, clevis pin retaining (4X PER MACHINE)
FAST008	nut, 44 quart back jacket bushing retaining	12	FAST004	clip, blade holder pin, 44 quart machines (2X PER MACHINE)
MECH001	center shaft, 44 quart casting	13	FAST002	pin, blade holder, 44 quart machines (2X PER MACHINE)
SEAL001	o-ring, 44 quart center shaft			
SEAL002	v-seal, 44 quart center shaft			
BLAD008	blade holder, 44 quart machines (2X PER MACHINE)			
BLAD006	blade insert, Delrin, 44 quart machines (2X PER MACHINE)			
BUSH001	bushing, dasher front, 1 1/2" long (* SEE NOTE BELOW)			
BUSH002	bushing, dasher front, 1 3/4" long (* SEE NOTE BELOW)			
BUSH003	bushing, dasher front, 1 5/8" long (* SEE NOTE BELOW)			

* CUSTOMER MUST MEASURE LENGTH TO DETERMINE CORRECT BUSHING

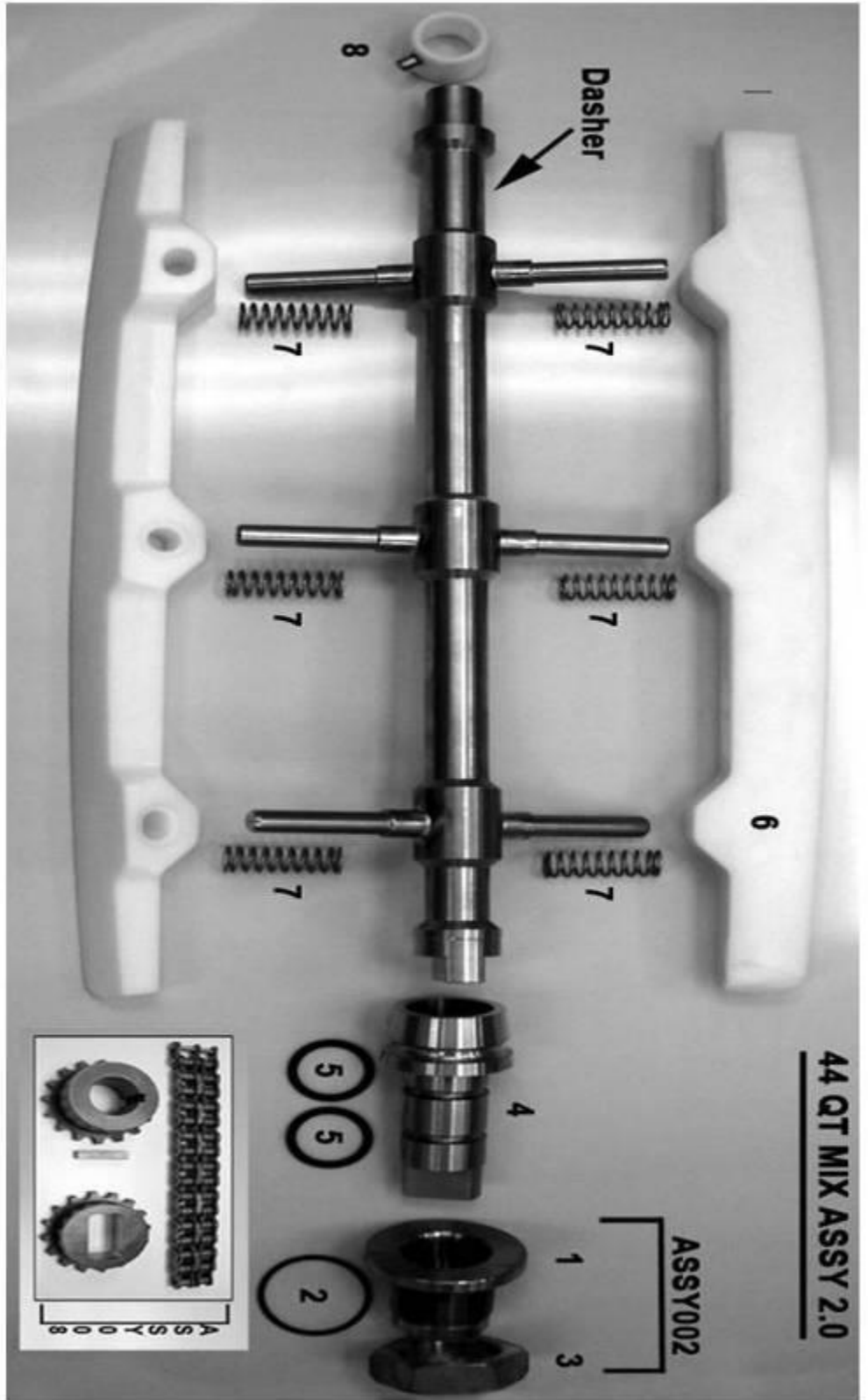

ASSY002	kit, 44 quart back jacket bushing replacement	8*	BUSH003	bushing, dasher front, 15/8" long (* SEE NOTE BELOW)	
ASSY008	kit, 44 quart chain coupling	8*	BUSH004	bushing, dasher front, 111/16" long (* SEE NOTE BELOW)	
1	BUSH008	bushing, back jacket, 44 quart	8*	BUSH005	bushing, dasher front, 13/4" long (* SEE NOTE BELOW)
2	SEAL003	O-ring, 44 quart back jacket bushing	8*	BUSH006	bushing, dasher front, 2" long (* SEE NOTE BELOW)
3	FAST008	nut, 44 quart back jacket bushing retaining			
4	MECH003	centershaft, 44 quart fabricated			
5	SEAL001	O-ring, 44 quart centershaft (2X PER MACHINE)			
6	BLAD004	blade, solid Delrin, 44 quart machines (2X PER MACHINE)			
7	SPRG003	blade spring, 44 quart machines (6X PER MACHINE)			
8*	BUSH001	bushing, dasher front, 11/2" long (* SEE NOTE BELOW)			
8*	BUSH002	bushing, dasher front, 19/16" long (* SEE NOTE BELOW)			

* CUSTOMER MUST MEASURE LENGTH TO DETERMINE CORRECT BUSHING



EMERY THOMPSON

World's Best Batch Freezers - Made in U.S.A. since 1905

44 QT DOOR ASSY 1.0

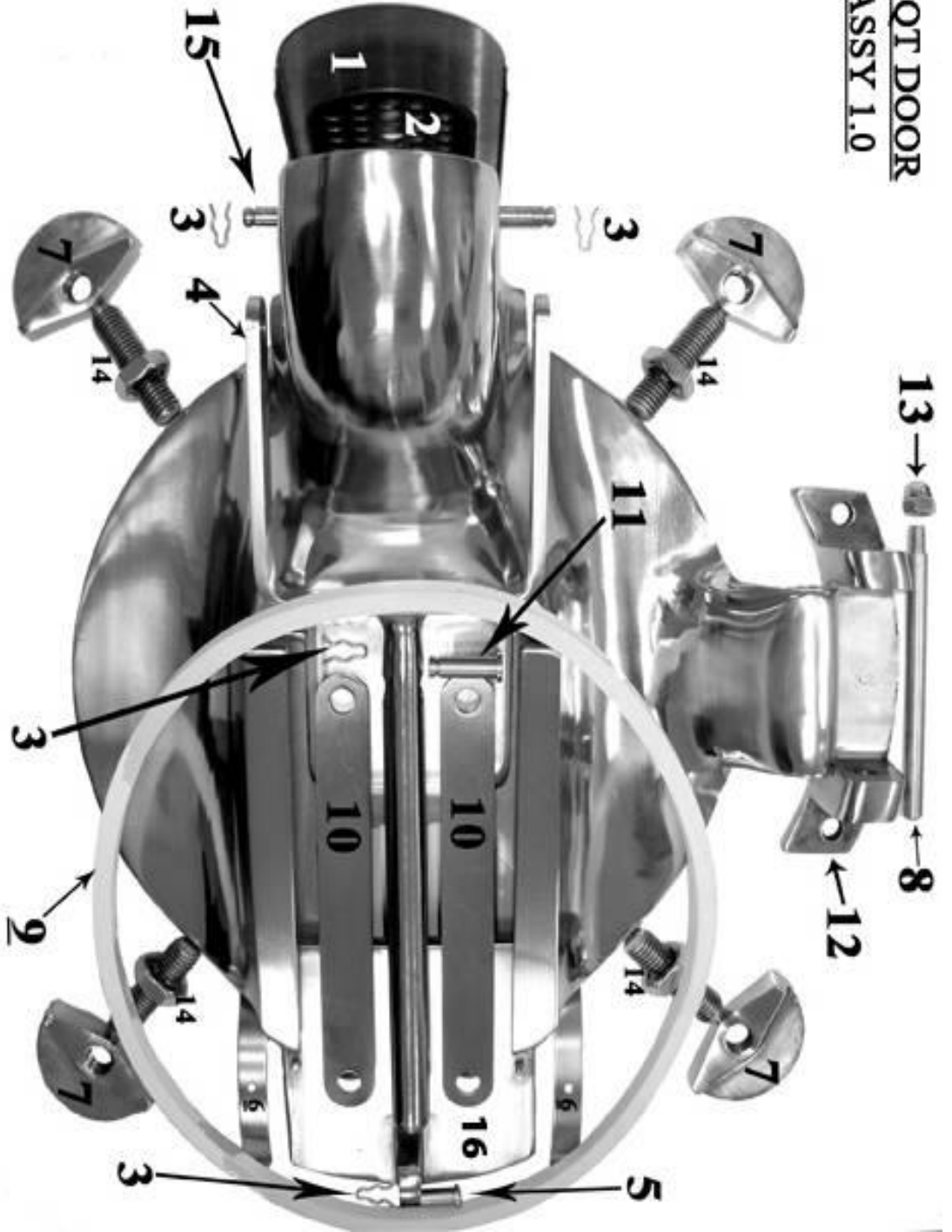

1	STML043	dust cover (lid) 44 qt spout opening	9	SEAL015	door seal, 44 quart, 3/8" x 3/8" white EPDM
2	STML014	guard, door throat, 44 quart machines, perforated	10	MECH037	linkage bar, 44 quart, stainless, gate-to-handle (x2)
3	FAST003	clip, bladeholder pin, 12 or 24 quart machines (small "A") (x4)	11	FAST042	pin, handle linkage, handle shaft end (longer) 12, 24 and 44 quart
4	MECH031	handle, gate operating, 44 quart	12	MECH035	hinge, 44 quart
5	FAST041	pin, handle linkage, gate end (shorter) 12, 24 and 44 quart	13	FAST040	nut, acorn, 3/8"-16 stainless, 12, 24 and 44 quart hinge pin top
6	SPRG007	spring, gate pressure, 12, 24 and 44 qt gates (x2)	14	FAST044	stud, knob mounting, 44 quart, threaded 303 stainless, 5/8"-11 (x4)
7	MECH033	knob, cast 44 quart (x4)	15	FAST037	pin, handle pivot, 12, 24 and 44 qt machines, w/ groove each end
8	FAST039	pin, hinge, 44 quart brass	16	MECH048	Gate, cast 44 quart



TROUBLESHOOTING

Also see our online Help Desk at www.emerythompson.com/help-desk.html

Problem	Solution
<i>Dasher motor starts but the compressor does not come on</i>	<u>Reset Mechanical Pressure Control Switch*</u>

How to Reset the Mechanical Pressure Control Switch

(*Note: This applies only to machines having a mechanical pressure switch - please see next section for resetting the digital pressure control switch on newer machines. Contact Emery Thompson for further information.)

In transit from our factory to your business the machine is jostled by the delivery truck. Your machine is safe and well secured for shipping but the pressure control switch might trip off. This will keep the condensing unit (freezing compressor) from turning on. It's a simple fix. Look at the photos to pick out which model Emery Thompson you own and the location of the pressure control. Remove the appropriate panel to access the pressure control. The control is black in color and is 5" long by 3" tall and says "Copeland" on the face of the control. Also on the face are two windows looking into gauges.

On top of the pressure control on the top right of the control is a small button. This is the reset. Push the reset button once and this will reset your compressor. *Caution* - it is possible for the compressor to start up (cycle) as soon as the button is pushed. Otherwise your compressor will start when the refrigeration switch on the front of the machine is flipped on.

44 BLT

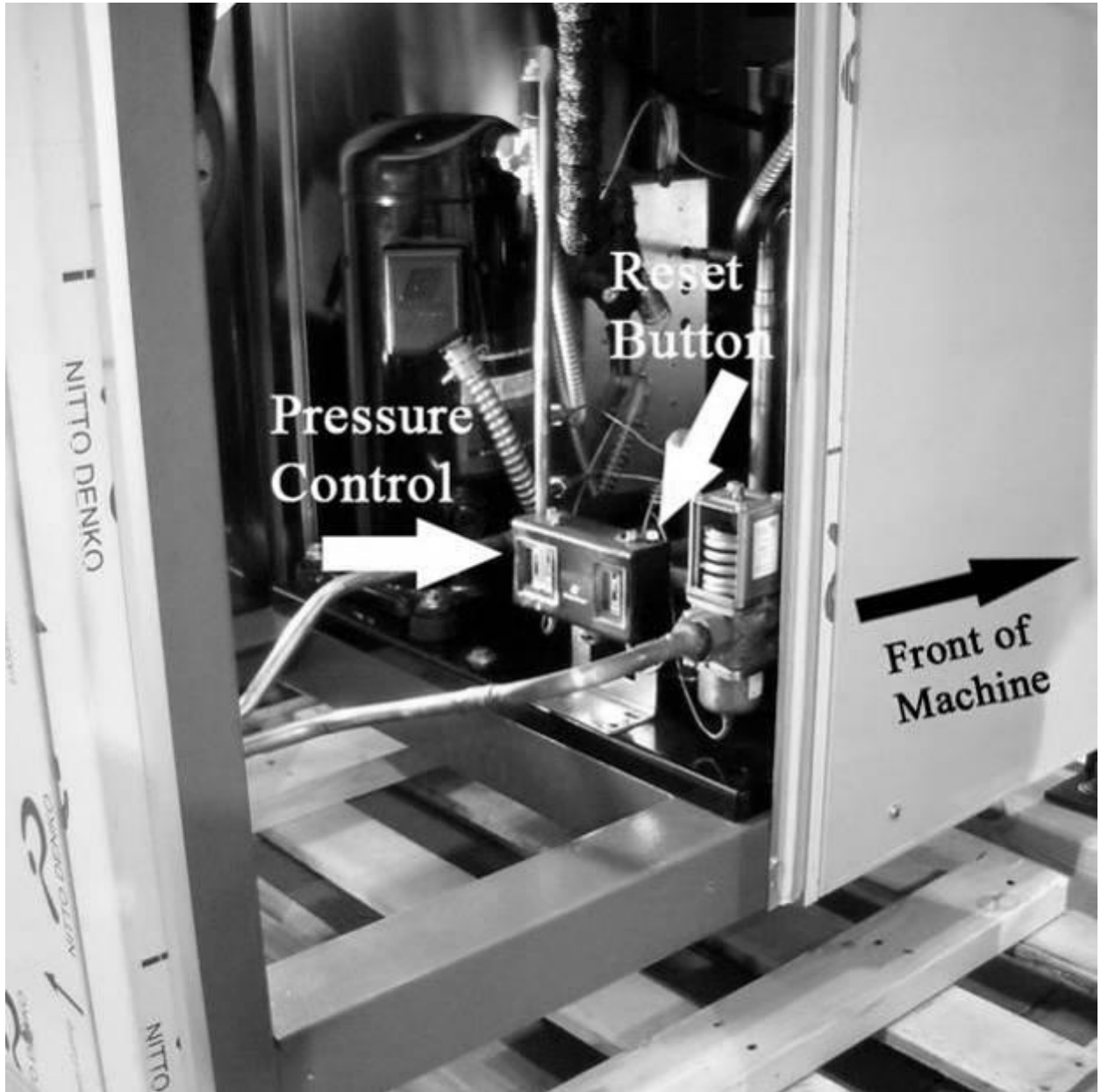

12 & 24 Quart Water Cooled

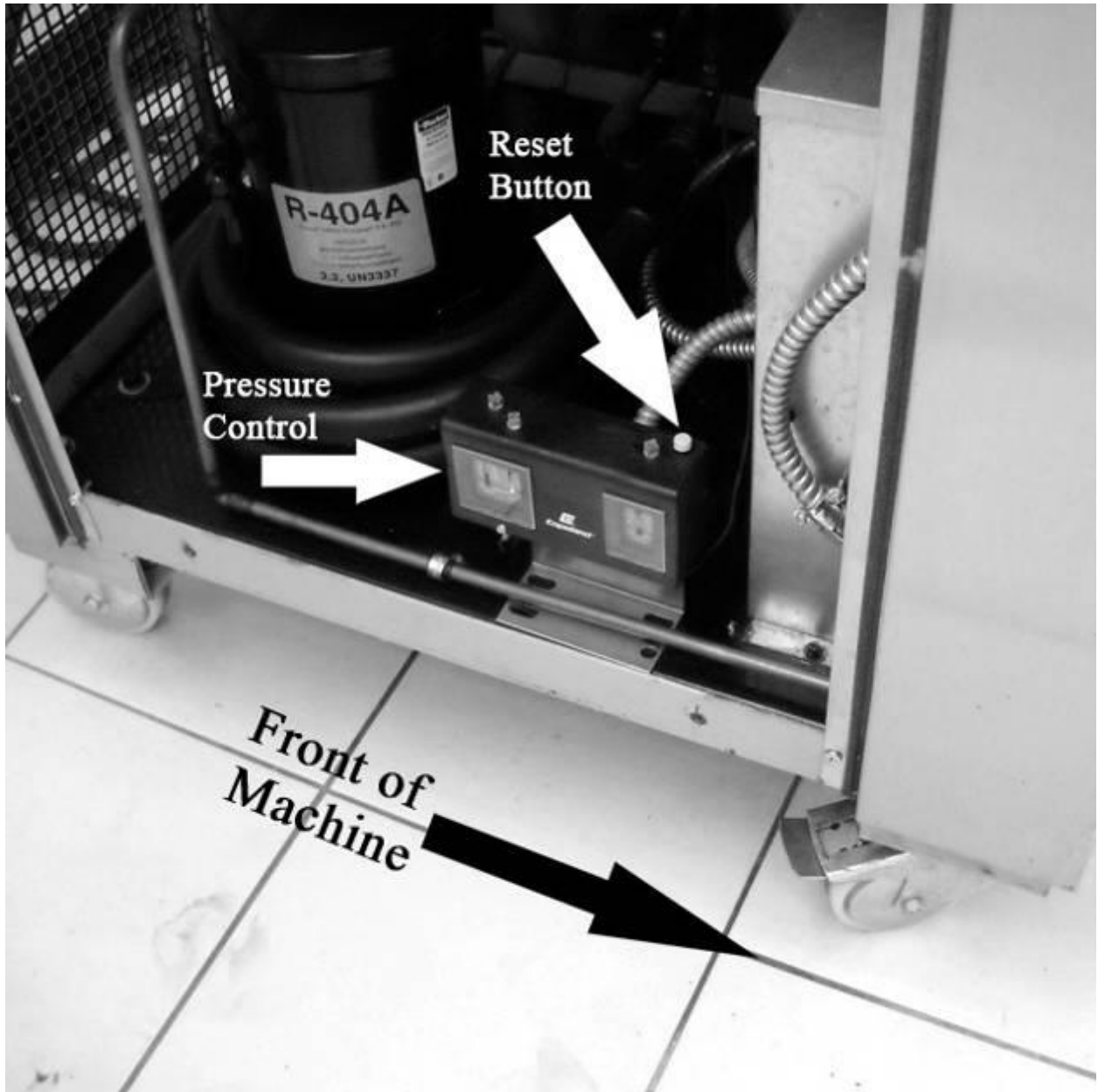

12 & 24 Quart Air Cooled

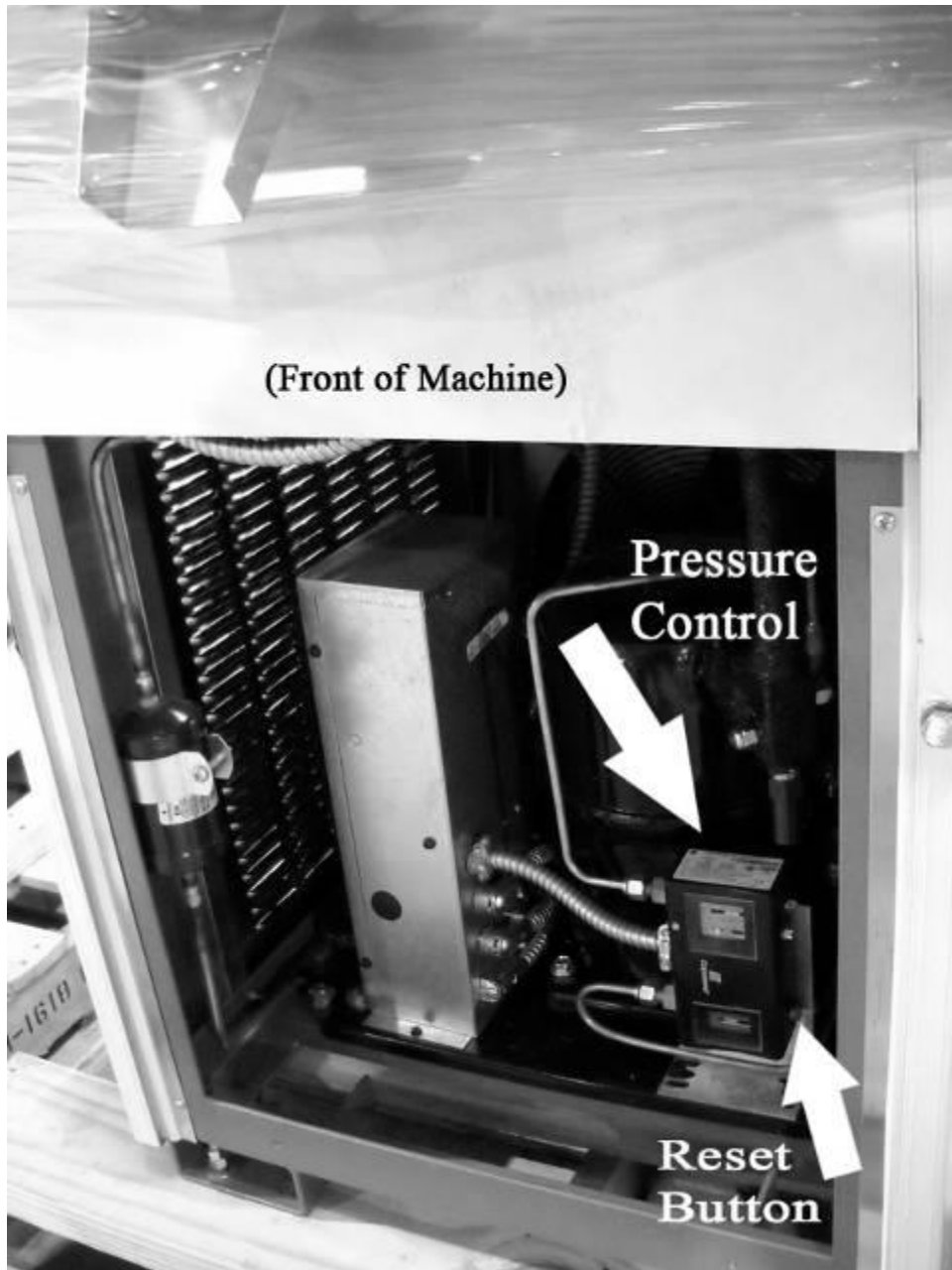

Also, if your machine sits for a long time (closed for winter) and the power is turned off to the machine, you might have to follow this procedure to start your batch freezer.

Problem	Solution
<i>Dasher motor starts but the compressor does not come on.</i>	<u>Reset Digital Pressure Control Switch*</u>

How To Reset The Digital Pressure Control Switch

(*Note: This applies only to machines having a digital pressure control switch. Please contact Emery Thompson for further information.)

The pressure control switch is the device that shuts off the refrigeration compressor to prevent it from becoming damaged when the pressure on the low-pressure side of the refrigeration system gets too low or too high, or when the pressure on the high-pressure side of the refrigeration system gets too high.

Common issues that cause the pressure control switch to trip are:

All Units

- Long period of time between uses.
- Cleaning the cylinder with hot water.

Water Cooled Units

- Cooling water not turned on.
- Cooling water line kinked or crushed (pressure line and/or drain line).

Air Cooled Units

- Heat exchanger blocked or covered.
- Heat exchanger too close to the wall.
- Not enough clearance around unit.
- Room temperature exceeding 100° F.

To reset the pressure control switch:

1. Remove the stainless-steel panel that covers the pressure control switch.
 - a. For 12 and 24-quart machines, remove the front, bottom panel.
 - b. For 44-quart machines, remove the right side panel closest to the front.
2. Press and hold the “START” button for 3 seconds. (See photo on next page.)
3. Release the “START” button briefly.
4. Press and hold the “START” button for 3 seconds, again.
5. The digital display should read “RST”.
6. Replace the stainless-steel panel.

12, 24 & 44-Quart Machines

